





Grayhill, Inc.

62S11-M5-020CH

Numéro d'article:	62S11-M5-020CH
Fabricant / marque:	Grayhill, Inc.
Description du produit:	ROTARY ENCODER OPTICAL 32PPR
Feuilles de données:	 62S11-M5-020CH.pdf
Statut RoHS	 Sans plomb / conforme à la directive RoHS
Bateau de	Hong Kong
Manière d'expédition	DHL/Fedex/TNT/UPS/EMS

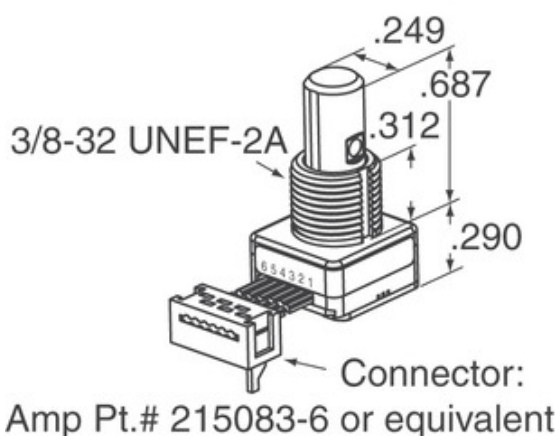
[DEMANDE DE DEVIS](#)

L'image peut être une représentation. Voir les spécifications pour les détails du produit.







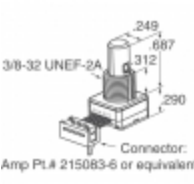

Spécifications de 62S11-M5-020CH

NUMÉRO D'ARTICLE	62S11-M5-020CH
FABRICANT	Grayhill, Inc.
LA DESCRIPTION	ROTARY ENCODER OPTICAL 32PPR
ÉTAT SANS PLOMB / ÉTAT ROHS	Sans plomb / conforme à la directive RoHS
FICHE TECHNIQUE	 62S11-M5-020CH.pdf
TENSION - ALIMENTATION	5V
STYLE DE RACCORDEMENT	Cable with Connector
SÉRIES	62S
VIE ROTATIONAL (CYCLES MIN)	1M
IMPULSIONS PAR TOUR	32
LE TYPE DE SORTIE	Quadrature (Incremental)
AUTRES NOMS	62S11M5020CH
ORIENTATION	Vertical
TYPE DE MONTAGE	Panel Mount
NIVEAU DE SENSIBILITÉ À L'HUMIDITÉ (MSL)	1 (Unlimited)
DÉLAI DE LIVRAISON STANDARD DU FABRICANT	8 Weeks
STATUT SANS PLOMB / STATUT ROHS	Lead free / RoHS Compliant
TYPE DE CODEUR	Optical
DETENT	Yes
COMMUTATEUR INTÉGRÉ	Yes
TYPE D'ACTIONNEUR	1/4" Dia Flatted End

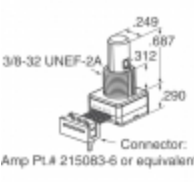
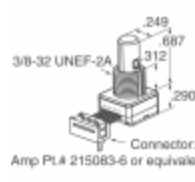
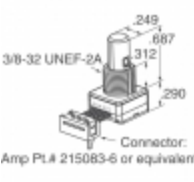
Tags associés

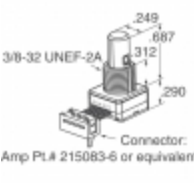
Grayhill, Inc. 62S11-M5-020CH	Distributeur 62S11-M5-020CH	Fournisseur 62S11-M5-020CH
Prix 62S11-M5-020CH	Photos de 62S11-M5-020CH	62S11-M5-020CH Image
Fiche technique PDF 62S11-M5-020CH	62S11-M5-020CH Télécharger la fiche technique	Fiche technique 62S11-M5-020CH
Stock 62S11-M5-020CH	Acheter 62S11-M5-020CH	Acheter Grayhill, Inc. 62S11-M5-020CH
Grayhill, Inc. 62S11-M5-020CH	Fournisseur Grayhill, Inc.	Distributeur Grayhill, Inc.
Grayhill, Inc. 62S11-M5-020CH	Grayhill Inc. 62S11-M5-020CH	

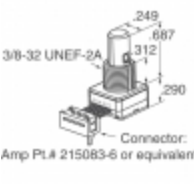
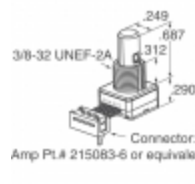
Produits connexes

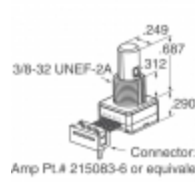
 <p>62S11-M5-040C Fabricants: Grayhill, Inc. La description: ROTARY ENCODER OPTICAL 32PPR En stock: Out stock</p> <p>RFQ</p>	 <p>62S11-M5-020C Fabricants: Grayhill, Inc. La description: ROTARY ENCODER OPT 32PPR 2" CBL En stock: Out stock</p> <p>RFQ</p>
 <p>62S11-M0-PV Fabricants: Grayhill, Inc. La description: ROTARY ENCODER OPTICAL 32PPR En stock: Out stock</p> <p>RFQ</p>	 <p>62S11-M5-030CH Fabricants: Grayhill, Inc. La description: ROTARY ENCODER OPTICAL 32PPR En stock: Out stock</p> <p>RFQ</p>
 <p>62S11-M0-200S Fabricants: Grayhill, Inc. La description: ROTARY ENCODER OPTICAL 32PPR En stock: Out stock</p> <p>RFQ</p>	 <p>62S11-M5-050C Fabricants: Grayhill, Inc. La description: ROTARY ENCODER OPT 32PPR 5" CBL En stock: 558 pcs</p> <p>RFQ</p>
 <p>62S11-M5-030C Fabricants: Grayhill, Inc. La description: ROTARY ENCODER OPTICAL 32PPR En stock: Out stock</p> <p>RFQ</p>	 <p>62S11-M0-210SH Fabricants: Grayhill, Inc. La description: ROTARY ENCODER OPT 32PPR 20" CBL En stock: Out stock</p> <p>RFQ</p>
 <p>62S11-M5-020S Fabricants: Grayhill, Inc. La description: ROTARY ENCODER OPTICAL 32PPR En stock: Out stock</p> <p>RFQ</p>	 <p>62S11-M5-020SH Fabricants: Grayhill, Inc. La description: ROTARY ENCODER OPT 32PPR 2" CBL En stock: Out stock</p> <p>RFQ</p>
 <p>62S11-M0-P Fabricants: Grayhill, Inc. La description: ROTARY ENCODER OPTICAL 32PPR En stock: Out stock</p> <p>RFQ</p>	 <p>62S11-M0-PH Fabricants: Grayhill, Inc. La description: ROTARY ENCODER OPTICAL 32PPR En stock: Out stock</p> <p>RFQ</p>