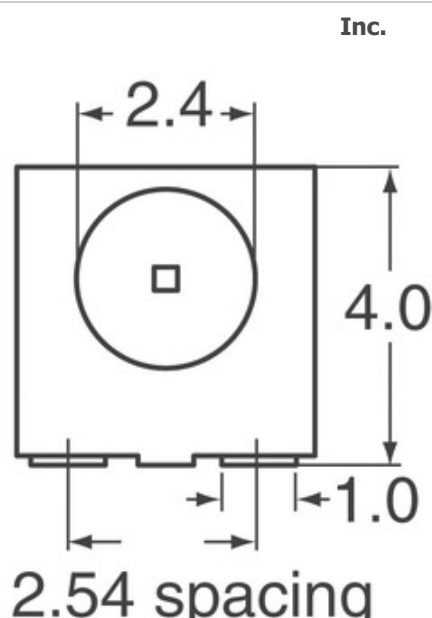

**OSRAM**  
 Opto Semiconductors

OSRAM Opto Semiconductors,

## SFH 325 FA-4-Z

Numéro d'article:	SFH 325 FA-4-Z
Fabricant / marque:	OSRAM Opto Semiconductors, Inc.
Description du produit:	PHOTOTRANSISTOR NPN 980NM 2PLCC
Feuilles de données:	<a href="#">PDF SFH 325 FA-4-Z.pdf</a>
Statut RoHs	 Sans plomb / conforme à la directive RoHS
Bateau de	Hong Kong
Manière d'expédition	DHL/Fedex/TNT/UPS/EMS

[DEMANDE DE DEVIS](#)

L'image peut être une représentation. Voir les spécifications pour les détails du produit.







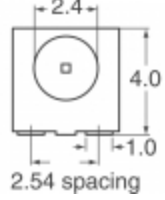

### Spécifications de SFH 325 FA-4-Z

NUMÉRO D'ARTICLE	SFH 325 FA-4-Z
FABRICANT	OSRAM Opto Semiconductors, Inc.
LA DESCRIPTION	PHOTOTRANSISTOR NPN 980NM 2PLCC
ÉTAT SANS PLOMB / ÉTAT ROHS	Sans plomb / conforme à la directive RoHS
FICHE TECHNIQUE	<a href="#">PDF SFH 325 FA-4-Z.pdf</a>
LONGUEUR D'ONDES	980nm
TENSION - COLLECTEUR-ÉMETTEUR DISRUPTIF (MAX)	35V
ANGLE DE VUE	120°
SÉRIES	SIDELED
PUISSANCE - MAX	165mW
EMBALLAGE	Tape & Reel (TR)
PACKAGE / BOÎTE	2-LCC (J-Lead)
AUTRES NOMS	Q65110A2485 SFH 325 FA-4 SFH 325 FA-4-Z-ND SFH325FA-4 SFH325FA-4-Z SFH325FA4 SFH325FA4Z
ORIENTATION	Side View
TEMPÉRATURE DE FONCTIONNEMENT	-40°C ~ 100°C (TA)
TYPE DE MONTAGE	Surface Mount, Right Angle
NIVEAU DE SENSIBILITÉ À L'HUMIDITÉ (MSL)	2 (1 Year)
DÉLAI DE LIVRAISON STANDARD DU FABRICANT	14 Weeks
STATUT SANS PLOMB / STATUT ROHS	Lead free / RoHS Compliant
DESCRIPTION DÉTAILLÉE	Phototransistor 980nm Side View 2-LCC (J-Lead)
COURANT - NOIR (ID) (MAX)	50nA
COURANT - COLLECTEUR (IC) (MAX)	15mA

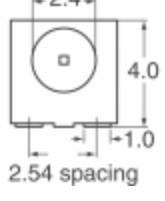
### Tags associés

OSRAM Opto Semiconductors, Inc. SFH 325 FA-4-Z	Distributeur SFH 325 FA-4-Z	Fournisseur SFH 325 FA-4-Z
Prix SFH 325 FA-4-Z	Photos de SFH 325 FA-4-Z	SFH 325 FA-4-Z Image
Fiche technique PDF SFH 325 FA-4-Z	SFH 325 FA-4-Z Télécharger la fiche technique	Fiche technique SFH 325 FA-4-Z
Stock SFH 325 FA-4-Z	Acheter SFH 325 FA-4-Z	Acheter OSRAM Opto Semiconductors, Inc. SFH 325 FA-4-Z
OSRAM Opto Semiconductors, Inc. SFH 325 FA-4-Z	Fournisseur OSRAM Opto Semiconductors, Inc.	Distributeur OSRAM Opto Semiconductors, Inc.
OSRAM Opto Semiconductors, Inc. SFH 325 FA-4-Z	OSRAM Opto Semiconductors Inc. SFH 325 FA-4-Z	

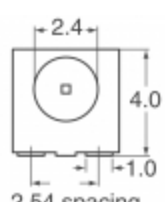
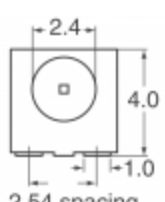
### Produits connexes

 <p><b>SFH 325-3-Z</b>          Fabricants: OSRAM Opto Semiconductors, Inc.          La description: PHOTOTRANSISTOR NPN 980NM 2PLCC          En stock: Out stock  <a href="#">RFQ</a></p>	 <p><b>SFH 331-JK</b>          Fabricants: OSRAM Opto Semiconductors, Inc.          La description: PHOTOTRANSISTOR/EMITTER SMD          En stock: Out stock  <a href="#">RFQ</a></p>
 <p><b>SFH 325-Z</b>          Fabricants: OSRAM Opto Semiconductors, Inc.          La description: PHOTOTRANSISTOR SIDELED          En stock: Out stock  <a href="#">RFQ</a></p>	 <p><b>SFH 325-4-Z</b>          Fabricants: OSRAM Opto Semiconductors, Inc.          La description: PHOTOTRANSISTOR NPN 980NM 2PLCC          En stock: Out stock  <a href="#">RFQ</a></p>
 <p><b>SFH 3211 FA-3/4-Z</b>          Fabricants: OSRAM Opto Semiconductors, Inc.          La description: PHOTOTRANSISTOR NPN 890NM REV GW          En stock: Out stock  <a href="#">RFQ</a></p>	 <p><b>SFH 3211 FA-Z</b>          Fabricants: OSRAM Opto Semiconductors, Inc.          La description: PHOTOTRANSISTOR NPN 890NM REV GW          En stock: Out stock  <a href="#">RFQ</a></p>
 <p><b>SFH 320G-3/4-Z</b>          Fabricants: OSRAM Opto Semiconductors, Inc.          La description: PHOTOTRANSISTOR NPN          En stock: Out stock  <a href="#">RFQ</a></p>	 <p><b>SFH 325 FA-3/4-Z</b>          Fabricants: OSRAM Opto Semiconductors, Inc.          La description: PHOTOTRANS NPN SIDELED 2SMD          En stock: Out stock  <a href="#">RFQ</a></p>
 <p><b>SFH 325 FA-Z</b>          Fabricants: OSRAM Opto Semiconductors, Inc.          La description: PHOTOTRANSISTOR NPN 980NM 2PLCC          En stock: Out stock  <a href="#">RFQ</a></p>	 <p><b>SFH 325 FA-3-Z</b>          Fabricants: OSRAM Opto Semiconductors, Inc.          La description: PHOTOTRANSISTOR NPN 980NM 2PLCC          En stock: Out stock  <a href="#">RFQ</a></p>
 <p><b>SFH 3219-Z</b>          Fabricants: OSRAM Opto Semiconductors, Inc.          La description: PHOTOTRANS NPN TOPLED W/LENS SMD          En stock: Out stock  <a href="#">RFQ</a></p>	 <p><b>SFH 325-3/4-Z</b>          Fabricants: OSRAM Opto Semiconductors, Inc.          La description: PHOTOTRANS NPN SIDELED 2SMD          En stock: Out stock  <a href="#">RFQ</a></p>