





Grayhill, Inc.

**70M-IAC15A**

Numéro d'article:	70M-IAC15A
Fabricant / marque:	Grayhill, Inc.
Description du produit	AC INPUT MODULE 240V
Feuilles de données:	 70M-IAC15A.pdf
Statut RoHS	 Sans plomb / conforme à la directive RoHS
Bateau de	Hong Kong
Manière d'expédition	DHL/Fedex/TNT/UPS/EMS

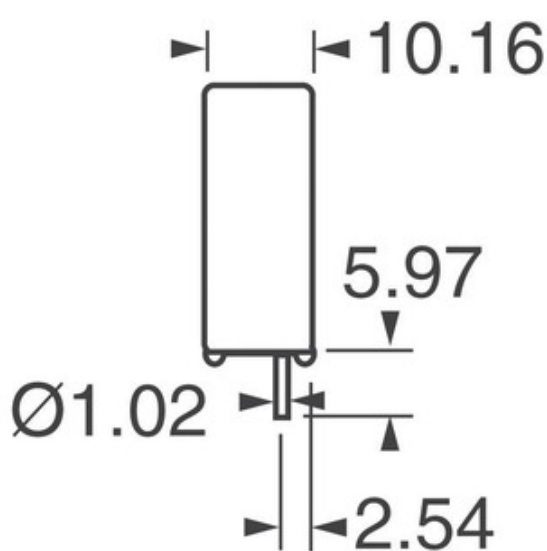
[DEMANDE DE DEVIS](#)

L'image peut être une représentation. Voir les spécifications pour les détails du produit.







## Spécifications de 70M-IAC15A

NUMÉRO D'ARTICLE	70M-IAC15A
FABRICANT	Grayhill, Inc.
LA DESCRIPTION	AC INPUT MODULE 240V
ÉTAT SANS PLOMB / ÉTAT ROHS	Sans plomb / conforme à la directive RoHS
FICHE TECHNIQUE	 70M-IAC15A.pdf
TENSION - SORTIE	15VDC
TENSION - ENTRÉE	240VAC
TYPE	AC Input Module
ACTIVER LE TEMPS	20ms
TEMPS DE DÉSACTIVATION	20ms
STYLE	Mini
SÉRIES	70
NIVEAU DE SENSIBILITÉ À L'HUMIDITÉ (MSL)	1 (Unlimited)
DÉLAI DE LIVRAISON STANDARD DU FABRICANT	8 Weeks
STATUT SANS PLOMB / STATUT ROHS	Lead free / RoHS Compliant
CARACTÉRISTIQUES	-
DESCRIPTION DÉTAILLÉE	AC Input Module Output Module 10mA 15VDC Output 240VAC Supply
COURANT - SORTIE	10mA
COURANT - ENTRÉE	6mA
COULEUR	Yellow

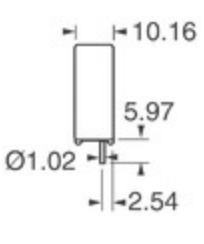
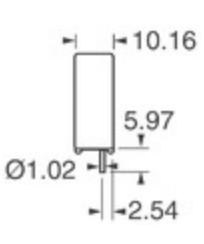
## Tags associés

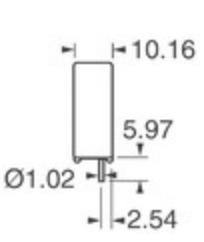
Grayhill, Inc. 70M-IAC15A	Distributeur 70M-IAC15A	Fournisseur 70M-IAC15A
Prix 70M-IAC15A	Photos de 70M-IAC15A	70M-IAC15A Image
Fiche technique PDF 70M-IAC15A	70M-IAC15A Télécharger la fiche technique	Fiche technique 70M-IAC15A
Stock 70M-IAC15A	Acheter 70M-IAC15A	Acheter Grayhill, Inc. 70M-IAC15A
Grayhill, Inc. 70M-IAC15A	Fournisseur Grayhill, Inc.	Distributeur Grayhill, Inc.
Grayhill, Inc. 70M-IAC15A	Grayhill Inc. 70M-IAC15A	

## Produits connexes

 <p><b>70M-IAC15</b> Fabricants: Grayhill, Inc. La description: AC INPUT MODULE 120V En stock: Out stock</p> <p><a href="#">RFQ</a></p>	 <p><b>70M-IAC24</b> Fabricants: Grayhill, Inc. La description: AC INPUT MODULE 120V En stock: Out stock</p> <p><a href="#">RFQ</a></p>
 <p><b>70M-IDC5N</b> Fabricants: Grayhill, Inc. La description: AC/DC INPUT MODULE 35-60V En stock: Out stock</p> <p><a href="#">RFQ</a></p>	 <p><b>70M-IDC5</b> Fabricants: Grayhill, Inc. La description: DC INPUT MODULE 3-32V En stock: 891 pcs</p> <p><a href="#">RFQ</a></p>
 <p><b>70M-IDC24</b> Fabricants: Grayhill, Inc. La description: DC INPUT MODULE 3-32V En stock: Out stock</p> <p><a href="#">RFQ</a></p>	 <p><b>70M-IAC24A</b> Fabricants: Grayhill, Inc. La description: AC INPUT MODULE 240V En stock: Out stock</p> <p><a href="#">RFQ</a></p>
 <p><b>70M-IAC5A</b> Fabricants: Grayhill, Inc. La description: AC INPUT MODULE 240V En stock: 37 pcs</p> <p><a href="#">RFQ</a></p>	 <p><b>70M-IAC5</b> Fabricants: Grayhill, Inc. La description: AC INPUT MODULE 120V En stock: 795 pcs</p> <p><a href="#">RFQ</a></p>
 <p><b>70M-IDC15</b> Fabricants: Grayhill, Inc. La description: DC INPUT MODULE 3-32V En stock: Out stock</p> <p><a href="#">RFQ</a></p>	 <p><b>70M-8A</b> Fabricants: Bussmann (Eaton) La description: FUSE CARTRIDGE 8A 125VAC/300VDC En stock: Out stock</p> <p><a href="#">RFQ</a></p>
 <p><b>70M-IDC5G</b> Fabricants: Grayhill, Inc. La description: AC/DC INPUT MODULE 35-60V En stock: Out stock</p> <p><a href="#">RFQ</a></p>	 <p><b>70M-IDC5NP</b> Fabricants: Grayhill, Inc. La description: AC/DC INPUT MOD 15-32V/10-32V En stock: Out stock</p> <p><a href="#">RFQ</a></p>