

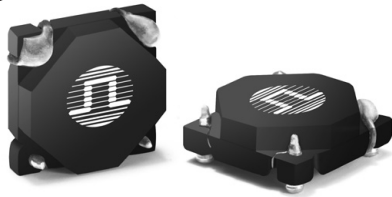



SMT CURRENT SENSE TRANSFORMERS

PA0368NL Series



-  **Height:** 3.3mm Max
-  **Footprint:** 8.4mm x 8.4mm Max
-  **Current Rating:** up to 4A
-  **Frequency Range:** 50kHz to 1MHz

Electrical Specifications @ 25°C — Operating Temperature -40°C to 130°C⁶

Part Number ^{4,5}	Turns ratio	Current Rating ¹	Secondary Inductance (mH MIN)	DCR (mΩ MAX)		Hipot (VRMS)
				Primary	Secondary	
PA0368.050NL	1:50	4	1.7	4	900	500
PA0368.070NL	1:70	4	3.3	4	1200	500
PA0368.080NL	1:80	4	4.3	4	1400	500
PA0368.100NL	1:100	4	6.7	4	1600	500
PA0368.125NL	1:125	4	10.4	4	1900	500

NOTES:

- The maximum current rating is based on temperature rise of the component and represents the DC current which will cause a typical temperature rise of 40°C with no airflow.
- To calculate the value of the terminating resistor (Rt) use the following formula: $R_t (\Omega) = V_{REF} * N / (I_{peak\ primary})$
- The peak flux density of device must remain below 2000 Gauss.
To calculate the peak flux density for a uni-polar current, use the following formula: $B_{pk} = 64.9 * V_{REF} * (Duty\ Cycle\ Max) * 10^5 / (N * Freq\ kHz)$
*for bi-polar current applications divide Bpk (as calculated above) by 2.
- Optional Tape & Reel packaging can be ordered by adding a "T" suffix to the part number (i.e. PA0368.050NL becomes PA0368.050NLT). Pulse complies to industry standard tape and reel specification EIA481.
- The "NL" suffix indicates an RoHS-compliant part number. Non-NL suffixed parts are not necessarily RoHS compliant, but are electrically and mechanically equivalent to NL versions. If a part number does not have the "NL" suffix, but an RoHS compliant version is required, please contact Pulse for availability.
- The temperature of the component (ambient plus temperature rise) must be within the stated operating temperature range.

Mechanical

Schematic

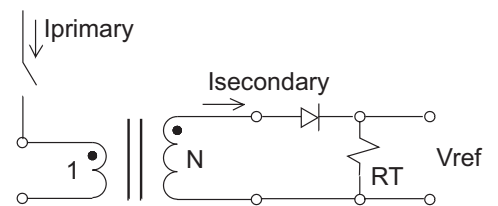
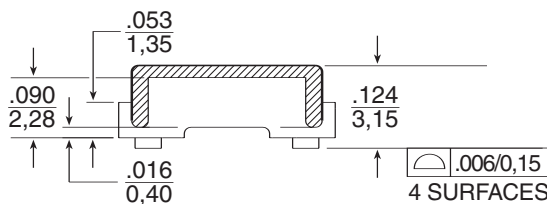
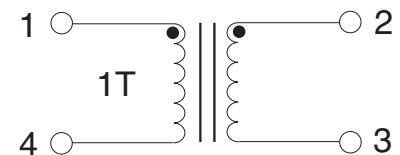
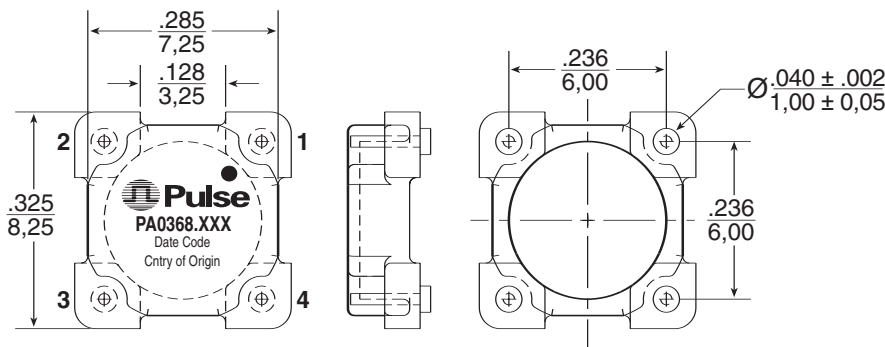

APPLICATION CIRCUIT

Weight0.3 grams
Tape & Reel1100/reel

Dimensions: $\frac{\text{Inches}}{\text{mm}}$
Unless otherwise specified, all tolerances are $\pm \frac{.010}{0.25}$