

Tunnel Series DAT-065-12-02-00-00

Direct-to-Air Thermoelectric Assembly



The Tunnel Series Direct-to-Air thermoelectric assembly is a thermoelectric based air conditioner designed to temperature control small chambers used in analytical and medical diagnostic instruments. The unique design offers premium fans pushing air across-high density heat sinks to minimize the number of air flow paths required to operate. The design utilizes custom thermoelectric modules to maximize cooling capacity with a high coefficient of performance. Moisture resistant insulation is used to keep condensation from penetrating the TEM cavity. The units operate on DC and are designed for an indoor lab use environment.

Laird Part Number: 387000873

Americas: +1.919.597.7300
Europe: +46.31.420530
Asia: +86.755.2714.1166
ets.sales@lairdtech.com
www.lairdtech.com

FEATURES

- Compact form factor
- Improved sealing for moisture protection
- Reliable solid-state operation
- RoHS compliant

APPLICATIONS

- Analytical storage compartment temperature control
- Medical diagnostic chamber refrigeration

SPECIFICATIONS	
TEA Model	DAT,065,12,02,00,00
Heat Transfer, Cold Side	Direct
Heat Transfer, Hot Side	Air
Cooling Power	65 W @ $\Delta T=0^{\circ}\text{C}$ and $T_a=35^{\circ}\text{C}$, Tolerance $\pm 10\%$
TEM Input Power	
Voltage, Nominal	12 VDC
Current, Nominal	5.1 Amps @ $\Delta T=0^{\circ}\text{C}$
Fan Input Power	
Voltage, Nominal	12 VDC
Current, Nominal	0.24 Amps
Dimension (L x W x H)	180 x 65 x 86 mm
Weight	1.02kg
Operating Temperature	-10°C to 50°C
Packaging	Individual cardboard box

PERFORMANCE CURVES

TEA performance at $T_h = 35^\circ\text{C}$

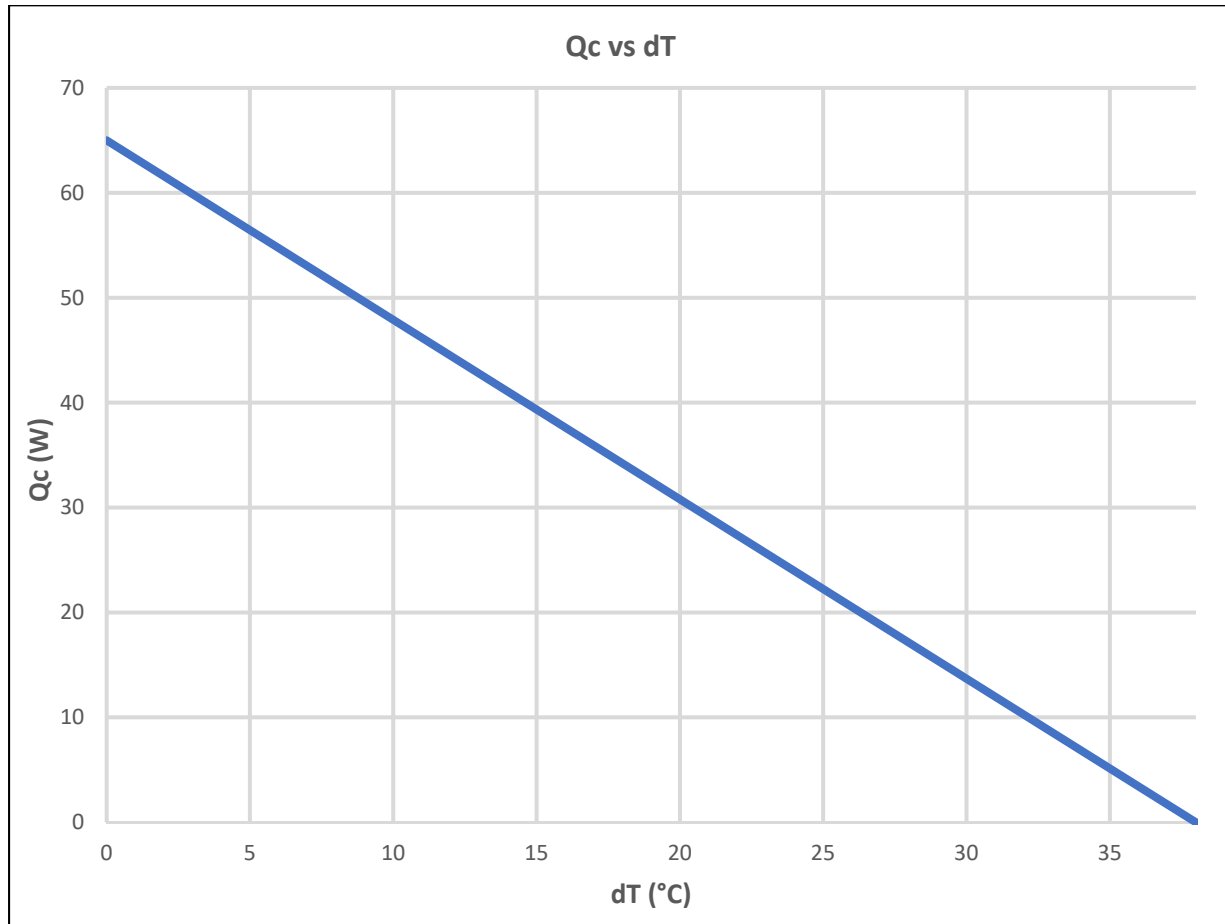

ISOMETRIC DRAWINGS

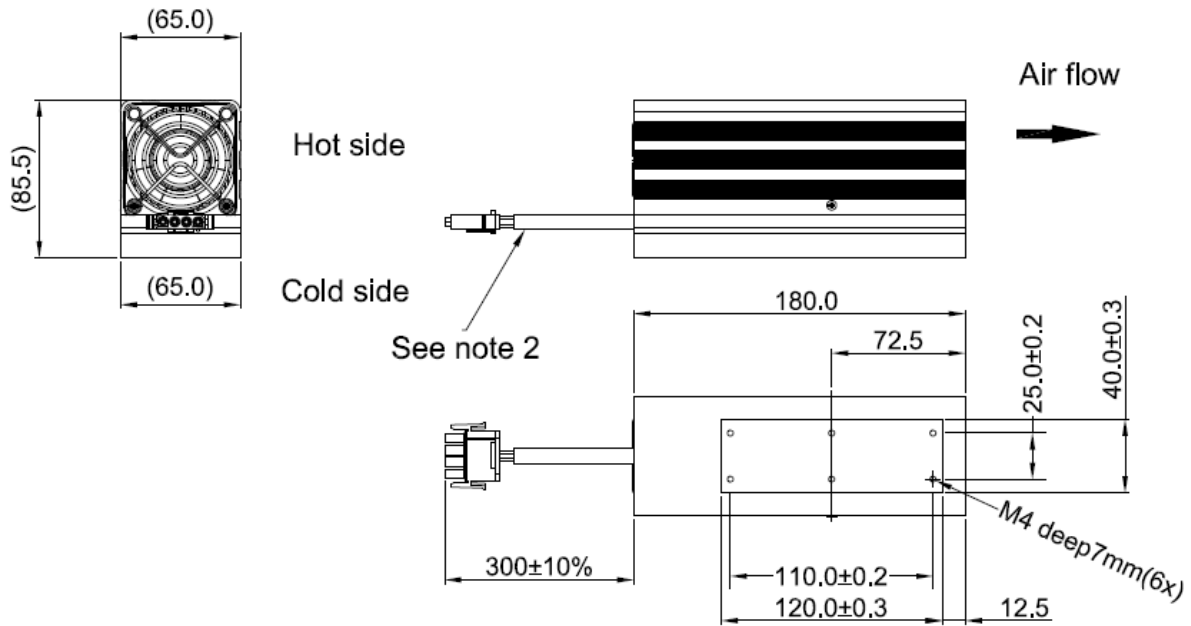

ELECTRICAL CONNECTIONS

OBJECT	WIRE TYPE	COLOR	TERMINAL	RECEPTICLE HOUSING	POLE	PLUG HOUSING
TEM +	AWG #18	Red	TE Connectivity 350547-1	TE Connectivity 350779-1	1	TE Connectivity 350780-1
TEM -		Black			2	
FAN HOT SIDE +	AWG#20	White			3	
FAN HOT SIDE -		Green			4	

INSTALLATION INSTRUCTIONS

1. For operation below dew point, recommend to position unit in vertical direction with wires facing down to allow for condensation to run off of unit. Drip tray may be required to collect moisture from surfaces at temperatures below dew point.
2. TE should not be used as part of the structure and is recommended to be protected from external forces.
3. The input power to TEA should be protected with fuse. Fuse rating should withstand 150% of nominal current rating for 60 seconds. This is valid at $T_a=35^{\circ}\text{C}$. Fuse ratings for other ambient temperatures ($x^{\circ}\text{C}$) can be calculated with the formula $I [x^{\circ}\text{C}] = I [35^{\circ}\text{C}] / (1+0.005*(x-35))$. This is valid when regulating with an On/Off regulation. At rapid temperature cycling where this is applicable, there can be a need for even higher fuse ratings.
4. Max ripple current on supply power should be $\leq 5\%$.
5. Switching power to TEMs at frequencies between 0.01Hz to 5KHz may degrade reliability and shorten life.

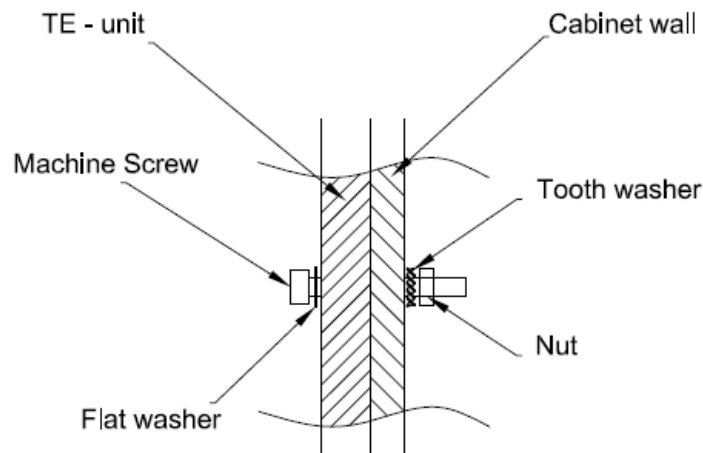

SERVICE

- Units are generally maintenance free, however occasionally it is recommended to clean the heat sinks and fans of debris. This is best done with compressed air.

LAIRD-TS-DAT-065-12-02-00-00-DATA-SHEET-101217

Any information furnished by Laird Technologies, Inc. and its agents is believed to be accurate and reliable. All specifications are subject to change without notice. Responsibility for the use and application of Laird Technologies materials rests with the end user. Laird Technologies makes no warranties as to the fitness, merchantability, suitability or non-infringement of any Laird Technologies materials or products for any specific or general uses. Laird Technologies shall not be liable for incidental or consequential damages of any kind. All Laird Technologies products are sold pursuant to the Laird Technologies' Terms and Conditions of sale in effect from time to time, a copy of which will be furnished upon request. © Copyright 2017 Laird Technologies, Inc. All Rights Reserved. Laird, Laird Technologies, the Laird Technologies Logo, and other marks are trademarks or registered trademarks of Laird Technologies, Inc. or an affiliate company thereof. Other product or service names may be the property of third parties. Nothing herein provides a license under any Laird Technologies or any third party intellectual property rights.