

**System pitch 5.08 mm (0.200 inch)  
SL-SMT 5.08/06/90G 3.2SN BK BX**

**Weidmüller Interface GmbH & Co. KG**  
Klingenbergstraße 16  
D-32758 Detmold  
Germany  
Fon: +49 5231 14-0  
Fax: +49 5231 14-2083  
www.weidmueller.com



High-temperature-resistant male connector, packed in box or tape. In tape with 1.5 mm solder pin optimised for automatic assembly. 3.2 mm solder pin suitable for reflow and wave soldering. These male connectors can be labelled and coded.

- 400 V (IEC) / 300 V (UL)
- 19 A (IEC) / 15 A (UL)

### General ordering data

Order No.	<a href="#">1780220000</a>
Part designation	SL-SMT 5.08/06/90G 3.2SN BK BX
Version	PCB plug-in connector, male header, 5.08 mm, No. of poles: 6, 90°, Solder pin length: 3.2 mm, tinned, black, Reflow solder connection, Box
GTIN (EAN)	4032248165544
Qty.	50 pc(s).
Packaging	Box

**System pitch 5.08 mm (0.200 inch)  
SL-SMT 5.08/06/90G 3.2SN BK BX**

Weidmüller Interface GmbH & Co. KG  
Klingenbergstraße 16  
D-32758 Detmold  
Germany  
Fon: +49 5231 14-0  
Fax: +49 5231 14-2083  
www.weidmueller.com

**Technical data**

**System parameters**

Fitted to PCB	Reflow solder connection	Outgoing elbow	90°
Pitch in mm	5.08 mm	Pitch in inch	0.2 inch
No. of poles	6	Solder pin length	3.2 mm
Can be coded	Yes	No. of rows	1
Number of solder pins per pole	1	L1 in mm	25.4 mm
L1 in inch	1 inch		

**Material data**

Insulating material	LCP GF	Colour	black
Insulating material group	IIIa	Flammability class UL 94	V-0
Contact material	CuSn	Contact surface	tinned
Highest continuous operating temperature, min.	-25 °C	Highest continuous operating temperature, max.	100 °C
Max. relative humidity during storage	80 %		

**DIN IEC rating data**

Rated current, min. No. of poles (Tu=20°C)	19 A	Rated current, max. No. of poles (Tu=20°C)	15 A
Rated current, no. of poles (Tu=40°C), min.	16 A	Rated current, no. of poles (Tu=40°C), max.	13 A
Rated voltage at overvoltage category/pollution degree III/3	250 V	Rated impulse withstand voltage for overvoltage class/pollution severity III/3	4 kV
Rated voltage for overvoltage class/pollution severity III/2	320 V	Rated impulse withstand voltage for overvoltage class/pollution severity III/2	4 kV
Rated voltage for overvoltage class/pollution severity II/2	400 V	Rated impulse withstand voltage for overvoltage class/pollution severity II/2	4 kV

**CSA rating data**

Rated voltage (Use group B)	300 V	Rated current (use group B)	15 A
Rated voltage (use group D)	300 V	Rated current (use group D)	10 A

**UL 1059 rating data**

Rated voltage (use group B)	300 V	Rated current (use group B)	15 A
Rated voltage (use group D)	300 V	Rated current (use group D)	10 A

**Approvals**

Approvals institutes	CSA; GOSTME25; UR; ROHS
----------------------	-------------------------

**Classifications**

ETIM 3.0	EC001284	eClass 5.1	27-26-07-04
eClass 6.0	27-26-07-04		

**Datasheet**

**System pitch 5.08 mm (0.200 inch)**  
**SL-SMT 5.08/06/90G 3.2SN BK BX**

**Weidmüller Interface GmbH & Co. KG**  
Klingenbergstraße 16  
D-32758 Detmold  
Germany  
Fon: +49 5231 14-0  
Fax: +49 5231 14-2083  
[www.weidmueller.com](http://www.weidmueller.com)

**Technical data****Notes**

Notes

- Additional colours on request
- Gold-plated contact surfaces on request
- Rated current related to rated cross-section and min. No. of poles.
- Diameter of solder eyelet  $D = 1.4 \pm 0.1$  mm
- Diameter of solder eyelet  $D = 1.5 \pm 0.1$  mm from 9-pole
- P on drg. = pitch
- Rated data refer only to the component itself. Clearance and creepage distances to other components are to be designed in accordance with the relevant application standards.

**Datasheet**

**System pitch 5.08 mm (0.200 inch)  
SL-SMT 5.08/06/90G 3.2SN BK BX**

Weidmüller Interface GmbH & Co. KG  
Klingenbergstraße 16  
D-32758 Detmold  
Germany  
Fon: +49 5231 14-0  
Fax: +49 5231 14-2083  
www.weidmueller.com

**Drawings**

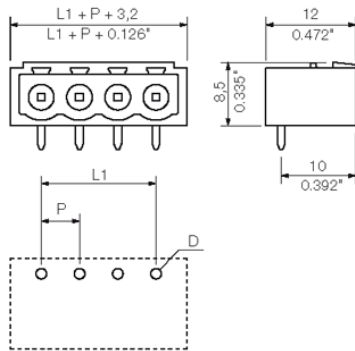

**System pitch 5.08 mm (0.200 inch)  
SL-SMT 5.08/06/90G 3.2SN BK BX**

**Weidmüller Interface GmbH & Co. KG**  
Klingenbergstraße 16  
D-32758 Detmold  
Germany  
Fon: +49 5231 14-0  
Fax: +49 5231 14-2083  
www.weidmueller.com

**Counterpart**
**BLZP 5.08/225 SN**

Clamping-yoke wire connection with right-angled (90° or 270°) or angled (225°) outlet direction. The female connectors provide space for labelling and can be coded. Can be fastened with flange or release latch. They feature an integrated plus/minus screw, protection against false insertion under clamping yoke. They are delivered with an opened clamping yoke.

- 0.2-2.5 mm<sup>2</sup> (IEC) / 26-12 AWG (UL)
- 400 V (IEC) / 300 V (UL)
- 17.5 A (IEC) / 10 A (UL)

**General ordering data**

Order No.	Part designation	Version	GTIN (EAN)	Qty.	Packaging
<a href="#">1946290000</a>	BLZP 5.08/06/225 SN OR BX	PCB plug-in connector, female plug, 5.08 mm, No. of poles: 6, 225°, Clamping yoke connection, Clamping range, max.: 4 mm <sup>2</sup> , Box	4032248621866	60 pc(s).	Box
<a href="#">1946600000</a>	BLZP 5.08/06/225 SN BK BX	PCB plug-in connector, female plug, 5.08 mm, No. of poles: 6, 225°, Clamping yoke connection, Clamping range, max.: 4 mm <sup>2</sup> , Box	4032248622375	60 pc(s).	Box

**BLZP 5.08/180 SN**

Female connectors with clamping yoke screw connection for conductor connection with straight (180°) outlet direction. The female connectors provide space for labelling and can be coded. Can be fastened with flange or release latch. They feature an integrated plus/minus screw, protection against false insertion under clamping yoke. They are delivered with an opened clamping yoke.

- 0.2-2.5 mm<sup>2</sup> (IEC) / 26-12 AWG (UL)
- 400 V (IEC) / 300 V (UL)
- 19 A (IEC) / 15 A (UL)

**General ordering data**

Order No.	Part designation	Version	GTIN (EAN)	Qty.	Packaging
<a href="#">1943850000</a>	BLZP 5.08/06/180 SN BK BX	PCB plug-in connector, female plug, 5.08 mm, No. of poles: 6, 180°, Clamping yoke connection, Clamping range, max.: 4 mm <sup>2</sup> , Box	4032248617999	45 pc(s).	Box
<a href="#">1943620000</a>	BLZP 5.08/06/180 SN OR BX	PCB plug-in connector, female plug, 5.08 mm, No. of poles: 6, 180°, Clamping yoke connection, Clamping range, max.: 4 mm <sup>2</sup> , Box	4032248617616	45 pc(s).	Box

## System pitch 5.08 mm (0.200 inch) SL-SMT 5.08/06/90G 3.2SN BK BX

**Weidmüller Interface GmbH & Co. KG**  
 Klingenbergstraße 16  
 D-32758 Detmold  
 Germany  
 Fon: +49 5231 14-0  
 Fax: +49 5231 14-2083  
 www.weidmueller.com

## Counterpart

### BLZP 5.00/270 SN

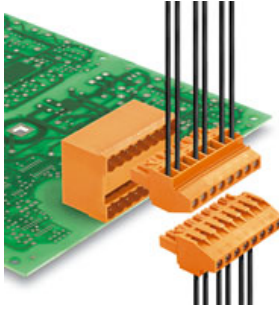

Socket connectors with clamping yoke screw connection for conductor connection with a right-angle (90° or 270°) outlet direction. The female connectors provide space for labelling and can be coded. Can be fastened with flange or release latch. They feature an integrated plus/minus screw, protection against false insertion under clamping yoke. They are delivered with an opened clamping yoke.

- 0.2-2.5 mm<sup>2</sup> (IEC) / 26-12 AWG (UL)
- 400 V (IEC) / 300 V (UL)
- 15 A (IEC) / 10 A (UL)

#### General ordering data

Order No.	Part designation	Version	GTIN (EAN)	Qty.	Packaging
<a href="#">1958830000</a>	BLZP 5.00/06/270 SN OR BX	PCB plug-in connector, female plug, 5.00 mm, No. of poles: 6, 90°, Clamping yoke connection, Clamping range, max.: 4 mm <sup>2</sup> , Box	4032248637669	60 pc(s).	Box
<a href="#">1959060000</a>	BLZP 5.00/06/270 SN BK BX	PCB plug-in connector, female plug, 5.00 mm, No. of poles: 6, 90°, Clamping yoke connection, Clamping range, max.: 4 mm <sup>2</sup> , Box	4032248637997	60 pc(s).	Box

### BLF 5.08/90 SN



Just as reliable as the tried-and-true original, with innovation in detail:

The BLF 5.0x – the PUSH-IN version of the BLZ 5.0x socket block – features a new connection system and a more compact design. Weidmüller's innovative PUSH-IN spring connection features a trend-setting, tool-free wire connection system that is simple to operate.

In terms of versatility, the BLF 5.0x offers just as much as the older versions:

- The choice of three wire outlet directions offers you proven design flexibility for your applications.
- Four flange variations, including the patented release latch, allow for user-friendly unplugging designs.

#### General ordering data

Order No.	Part designation	Version	GTIN (EAN)	Qty.	Packaging
<a href="#">1001570000</a>	BLF 5.08/06/90 SN OR BX	PCB plug-in connector, female plug, 5.08 mm, No. of poles: 6, 90°, PUSH IN, Clamping range, max.: 3.31 mm <sup>2</sup> , Box	4032248693375	60 pc(s).	Box
<a href="#">1000070001</a>	BLF 5.08/06/90 SN BK BX	PCB plug-in connector, female plug, 5.08 mm, No. of poles: 6, 90°, PUSH IN, Clamping range, max.: 3.31 mm <sup>2</sup> , Box	4032248690008	60 pc(s).	Box

## System pitch 5.08 mm (0.200 inch) SL-SMT 5.08/06/90G 3.2SN BK BX

**Weidmüller Interface GmbH & Co. KG**  
 Klingenbergstraße 16  
 D-32758 Detmold  
 Germany  
 Fon: +49 5231 14-0  
 Fax: +49 5231 14-2083  
 www.weidmueller.com

## Counterpart

### BLZ 5.00/270



Female connectors with clamping yoke screw connection. The female connectors provide space for labelling and can be coded. Packed in cardboard box.

- 0.20 - 2.5 mm<sup>2</sup> (IEC) / 26 - 12 AWG (UL)
- 400 V (IEC) / 300 V (UL)
- 15 A (IEC) / 10 A (UL)

### General ordering data

Order No.	Part designation	Version	GTIN (EAN)	Qty.	Packaging
<a href="#">1637850000</a>	BLZ 5.00/06/270 SN BK BX	PCB plug-in connector, female plug, 5.00 mm, No. of poles: 6, 270°, Clamping yoke connection, Clamping range, max.: 3.31 mm <sup>2</sup> , Box	4008190275099	60 pc(s).	Box
<a href="#">1637620000</a>	BLZ 5.00/06/270 SN OR BX	PCB plug-in connector, female plug, 5.00 mm, No. of poles: 6, 270°, Clamping yoke connection, Clamping range, max.: 3.31 mm <sup>2</sup> , Box	4008190274863	60 pc(s).	Box

### BLL 5.08/180



Female connector for PCB mounting. The solder pin length is optimised for wave flow soldering. Packed in cardboard box.

- 400 V (IEC) / 300 V (UL)
- 23 A (IEC) / 15 A (UL)

### General ordering data

Order No.	Part designation	Version	GTIN (EAN)	Qty.	Packaging
<a href="#">1630750000</a>	BLL 5.08/06/180 3.2SN OR BX	PCB plug-in connector, female header, 5.08 mm, No. of poles: 6, 180°, Solder pin length: 3.2 mm, tinned, Orange, Solder connection, Box	4008190204174	50 pc(s).	Box

## System pitch 5.08 mm (0.200 inch) SL-SMT 5.08/06/90G 3.2SN BK BX

**Weidmüller Interface GmbH & Co. KG**  
 Klingenbergstraße 16  
 D-32758 Detmold  
 Germany  
 Fon: +49 5231 14-0  
 Fax: +49 5231 14-2083  
 www.weidmueller.com

## Counterpart

### BLZF 5.08/180



Female connectors for connecting conductors with tension clamp system, straight 180° outlet direction. The female connectors include space for labelling and can be coded. Packed in cardboard box.

- 0.20 - 2.5 mm<sup>2</sup> (IEC) / 26 - 12 AWG (UL)
- 400 V (IEC) / 300 V (UL)
- 17 A (IEC) / 15 A (UL)

### General ordering data

Order No.	Part designation	Version	GTIN (EAN)	Qty.	Packaging
<a href="#">1707730000</a>	BLZF 5.08/06/180 SN BK BX	PCB plug-in connector, female plug, 5.08 mm, No. of poles: 6, 180°, Tension clamp connection, Clamping range, max.: 3.31 mm <sup>2</sup> , Box	4008190316730	60 pc(s).	Box
<a href="#">1707500000</a>	BLZF 5.08/06/180 SN OR BX	PCB plug-in connector, female plug, 5.08 mm, No. of poles: 6, 180°, Tension clamp connection, Clamping range, max.: 3.31 mm <sup>2</sup> , Box	4008190395872	60 pc(s).	Box

### BLF 5.00/90 SN



Just as reliable as the tried-and-true original, with innovation in detail:

The BLF 5.0x – the PUSH-IN version of the BLZ 5.0x socket block – features a new connection system and a more compact design. Weidmüller's innovative PUSH-IN spring connection features a trend-setting, tool-free wire connection system that is simple to operate.

In terms of versatility, the BLF 5.0x offers just as much as the older versions:

- The choice of three wire outlet directions offers you proven design flexibility for your applications.
- Four flange variations, including the patented release latch, allow for user-friendly unplugging designs.

### General ordering data

Order No.	Part designation	Version	GTIN (EAN)	Qty.	Packaging
<a href="#">1979310000</a>	BLF 5.00/06/90 SN BK BX	PCB plug-in connector, female plug, 5.00 mm, No. of poles: 6, 90°, PUSH IN, Clamping range, max.: 3.31 mm <sup>2</sup> , Box	4032248674510	60 pc(s).	Box
<a href="#">1980210000</a>	BLF 5.00/06/90 SN OR BX	PCB plug-in connector, female plug, 5.00 mm, No. of poles: 6, 90°, PUSH IN, Clamping range, max.: 3.31 mm <sup>2</sup> , Box	4032248675296	60 pc(s).	Box



## System pitch 5.08 mm (0.200 inch) SL-SMT 5.08/06/90G 3.2SN BK BX

**Weidmüller Interface GmbH & Co. KG**  
 Klingenbergstraße 16  
 D-32758 Detmold  
 Germany  
 Fon: +49 5231 14-0  
 Fax: +49 5231 14-2083  
 www.weidmueller.com

## Counterpart

### BLIDC 5.08



Female connectors for conductor connection with IDC system. The female connectors provide space for labelling and can be coded. Packed in cardboard box.

- 0.35 - 0.75 mm<sup>2</sup> (IEC) / 22 - 20 AWG (UL)
- 400 V (IEC) / 300 V (UL)
- 11 A (IEC) / 5 A (UL)

### General ordering data

Order No.	Part designation	Version	GTIN (EAN)	Qty.	Packaging
<a href="#">1724980000</a>	BLIDC 5.08/06/180 SN OR BX	PCB plug-in connector, female plug, 5.08 mm, No. of poles: 6, 180°, IDC terminal, Clamping range, max.: 0.75 mm <sup>2</sup> , Box	4008190377328	50 pc(s).	Box

### BLZP 5.00/90 SN



Socket connectors with clamping yoke screw connection for conductor connection with a right-angle (90° or 270°) outlet direction. The female connectors provide space for labelling and can be coded. Can be fastened with flange or release latch. They feature an integrated plus/minus screw, protection against false insertion under clamping yoke. They are delivered with an opened clamping yoke.

- 0.2-2.5 mm<sup>2</sup> (IEC) / 26-12 AWG (UL)
- 400 V (IEC) / 300 V (UL)
- 15 A (IEC) / 10 A (UL)

### General ordering data

Order No.	Part designation	Version	GTIN (EAN)	Qty.	Packaging
<a href="#">1958610000</a>	BLZP 5.00/06/90 SN BK BX	PCB plug-in connector, female plug, 5.00 mm, No. of poles: 6, 90°, Clamping yoke connection, Clamping range, max.: 4 mm <sup>2</sup> , Box	4032248637348	60 pc(s).	Box
<a href="#">1958260000</a>	BLZP 5.00/06/90 SN OR BX	PCB plug-in connector, female plug, 5.00 mm, No. of poles: 6, 90°, Clamping yoke connection, Clamping range, max.: 4 mm <sup>2</sup> , Box	4032248637126	60 pc(s).	Box

## System pitch 5.08 mm (0.200 inch) SL-SMT 5.08/06/90G 3.2SN BK BX

**Weidmüller Interface GmbH & Co. KG**  
 Klingenbergstraße 16  
 D-32758 Detmold  
 Germany  
 Fon: +49 5231 14-0  
 Fax: +49 5231 14-2083  
 www.weidmueller.com

## Counterpart

### BLZ 5.00/90

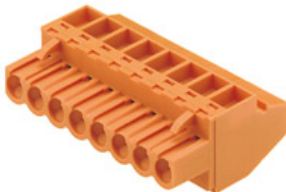

Female connectors with clamping yoke screw connection. The female connectors provide space for labelling and can be coded. Packed in cardboard box.

- 0.20 - 2.5 mm<sup>2</sup> (IEC) / 26 - 12 AWG (UL)
- 400 V (IEC) / 300 V (UL)
- 15 A (IEC) / 10 A (UL)

### General ordering data

Order No.	Part designation	Version	GTIN (EAN)	Qty.	Packaging
<a href="#">1636930000</a>	BLZ 5.00/06/90 SN BK BX	PCB plug-in connector, female plug, 5.00 mm, No. of poles: 6, 90°, Clamping yoke connection, Clamping range, max.: 3.31 mm <sup>2</sup> , Box	4008190274177	60 pc(s).	Box
<a href="#">1635980000</a>	BLZ 5.00/06/90 SN OR BX	PCB plug-in connector, female plug, 5.00 mm, No. of poles: 6, 90°, Clamping yoke connection, Clamping range, max.: 3.31 mm <sup>2</sup> , Box	4008190265816	60 pc(s).	Box

### BLZF 5.08/90



Female connectors for connecting conductors with tension clamp system. The female connectors include space for labelling and can be coded. Packed in cardboard box.

- 0.20 - 2.5 mm<sup>2</sup> (IEC) / 26 - 12 AWG (UL)
- 400 V (IEC) / 300 V (UL)
- 16.5 A (IEC) / 10 A (UL)

### General ordering data

Order No.	Part designation	Version	GTIN (EAN)	Qty.	Packaging
<a href="#">1671060000</a>	BLZF 5.08/06/90 SN BK BX	PCB plug-in connector, female plug, 5.08 mm, No. of poles: 6, 90°, Tension clamp connection, Clamping range, max.: 3.31 mm <sup>2</sup> , Box	4008190432737	60 pc(s).	Box
<a href="#">1670830000</a>	BLZF 5.08/06/90 SN OR BX	PCB plug-in connector, female plug, 5.08 mm, No. of poles: 6, 90°, Tension clamp connection, Clamping range, max.: 3.31 mm <sup>2</sup> , Box	4008190432430	50 pc(s).	Box

## System pitch 5.08 mm (0.200 inch) SL-SMT 5.08/06/90G 3.2SN BK BX

**Weidmüller Interface GmbH & Co. KG**  
 Klingenbergstraße 16  
 D-32758 Detmold  
 Germany  
 Fon: +49 5231 14-0  
 Fax: +49 5231 14-2083  
 www.weidmueller.com

## Counterpart

### BL 5.00



Female connectors for conductor connection in leaf spring system. Packed in cardboard box. The female connectors provide space for labelling. Packed in cardboard box.

- 0.2 - 1.5 mm<sup>2</sup> (IEC) / 26 - 14 AWG (UL)
- 400 V (IEC) / 300 V (UL)
- 11 A (IEC) / 10 A (UL)

### General ordering data

Order No.	Part designation	Version	GTIN (EAN)	Qty.	Packaging
<a href="#">1730740000</a>	BL 5.00/06/180 SN BK BX	PCB plug-in connector, female plug, 5.00 mm, No. of poles: 6, 180°, Leaf spring connection, Clamping range, max.: 2.08 mm <sup>2</sup> , Box	4008190387297	50 pc(s).	Box
<a href="#">1723150000</a>	BL 5.00/06/180 SN OR BX	PCB plug-in connector, female plug, 5.00 mm, No. of poles: 6, 180°, Leaf spring connection, Clamping range, max.: 2.08 mm <sup>2</sup> , Box	4032248002559	50 pc(s).	Box

### BLZP 5.00/180 SN



Female connectors with clamping yoke screw connection for conductor connection with straight (180°) outlet direction. The female connectors provide space for labelling and can be coded. Can be fastened with flange or release latch. They feature an integrated plus/minus screw, protection against false insertion under clamping yoke. They are delivered with an opened clamping yoke.

- 0.2-2.5 mm<sup>2</sup> (IEC) / 26-12 AWG (UL)
- 400 V (IEC) / 300 V (UL)
- 19 A (IEC) / 15 A (UL)

### General ordering data

Order No.	Part designation	Version	GTIN (EAN)	Qty.	Packaging
<a href="#">1954450000</a>	BLZP 5.00/06/180 SN OR BX	PCB plug-in connector, female plug, 5.00 mm, No. of poles: 6, 180°, Clamping yoke connection, Clamping range, max.: 4 mm <sup>2</sup> , Box	4032248633166	45 pc(s).	Box
<a href="#">1955530000</a>	BLZP 5.00/06/180 SN BK BX	PCB plug-in connector, female plug, 5.00 mm, No. of poles: 6, 180°, Clamping yoke connection, Clamping range, max.: 4 mm <sup>2</sup> , Box	4032248634026	45 pc(s).	Box

## System pitch 5.08 mm (0.200 inch) SL-SMT 5.08/06/90G 3.2SN BK BX

**Weidmüller Interface GmbH & Co. KG**  
 Klingenbergstraße 16  
 D-32758 Detmold  
 Germany  
 Fon: +49 5231 14-0  
 Fax: +49 5231 14-2083  
 www.weidmueller.com

## Counterpart

### BLZP 5.08/270 SN

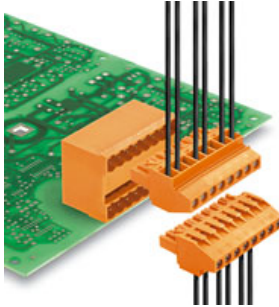

Socket connectors with clamping yoke screw connection for conductor connection with a right-angle (90° or 270°) outlet direction. The female connectors provide space for labelling and can be coded. Can be fastened with flange or release latch. They feature an integrated plus/minus screw, protection against false insertion under clamping yoke. They are delivered with an opened clamping yoke.

- 0.2-2.5 mm<sup>2</sup> (IEC) / 26-12 AWG (UL)
- 400 V (IEC) / 300 V (UL)
- 15 A (IEC) / 10 A (UL)

#### General ordering data

Order No.	Part designation	Version	GTIN (EAN)	Qty.	Packaging
<a href="#">1949060000</a>	BLZP 5.08/06/270 SN BK BX	PCB plug-in connector, female plug, 5.08 mm, No. of poles: 6, 270°, Clamping yoke connection, Clamping range, max.: 4 mm <sup>2</sup> , Box	4032248626519	60 pc(s).	Box
<a href="#">1948830000</a>	BLZP 5.08/06/270 SN OR BX	PCB plug-in connector, female plug, 5.08 mm, No. of poles: 6, 270°, Clamping yoke connection, Clamping range, max.: 4 mm <sup>2</sup> , Box	4032248626281	60 pc(s).	Box

### BLIDC 5.08B



Female connectors for conductor connection with IDC system. The female connectors provide space for labelling and can be coded. Packed in cardboard box.

- 0.35 - 0.75 mm<sup>2</sup> (IEC) / 22 - 20 AWG (UL)
- 400 V (IEC) / 300 V (UL)
- 11 A (IEC) / 5 A (UL)

#### General ordering data

Order No.	Part designation	Version	GTIN (EAN)	Qty.	Packaging
<a href="#">1759540000</a>	BLIDC 5.08/06/180B SN OR BX	PCB plug-in connector, female plug, 5.08 mm, No. of poles: 6, 180°, IDC terminal, Clamping range, max.: 0.75 mm <sup>2</sup> , Box	4032248069774	50 pc(s).	Box
<a href="#">1759650000</a>	BLIDC 5.08/06/180B SN BK BX	PCB plug-in connector, female plug, 5.08 mm, No. of poles: 6, 180°, IDC terminal, Clamping range, max.: 0.75 mm <sup>2</sup> , Box	4032248069880	50 pc(s).	Box

## System pitch 5.08 mm (0.200 inch) SL-SMT 5.08/06/90G 3.2SN BK BX

**Weidmüller Interface GmbH & Co. KG**  
Klingenbergstraße 16  
D-32758 Detmold  
Germany  
Fon: +49 5231 14-0  
Fax: +49 5231 14-2083  
www.weidmueller.com

## Counterpart

### BLZFS 5.00/180



Female connectors for connecting conductors with tension clamp system, straight 180° outlet direction in thin-element design. The female connectors include space for labelling and can be coded. Packed in cardboard box.

- 0.20 - 2.5 mm<sup>2</sup> (IEC) / 26 - 14 AWG (UL)
- 400 V (IEC) / 300 V (UL)
- 17 A (IEC) / 10 A (UL)

### General ordering data

Order No.	Part designation	Version	GTIN (EAN)	Qty.	Packaging
<a href="#">1696410000</a>	BLZFS 5.00/06/180 SN OR BX	PCB plug-in connector, female plug, 5.00 mm, No. of poles: 6, 180°, Tension clamp connection, Clamping range, max.: 2.5 mm <sup>2</sup> , Box	4008190878436	50 pc(s).	Box
<a href="#">1696640000</a>	BLZFS 5.00/06/180 SN BK BX	PCB plug-in connector, female plug, 5.00 mm, No. of poles: 6, 180°, Tension clamp connection, Clamping range, max.: 2.5 mm <sup>2</sup> , Box	4008190878665	50 pc(s).	Box

### BL 5.08



Female connectors for conductor connection in leaf spring system. Packed in cardboard box. The female connectors provide space for labelling. Packed in cardboard box.

- 0.2 - 1.5 mm<sup>2</sup> (IEC) / 26 - 14 AWG (UL)
- 400 V (IEC) / 300 V (UL)
- 11 A (IEC) / 10 A (UL)

### General ordering data

Order No.	Part designation	Version	GTIN (EAN)	Qty.	Packaging
<a href="#">1716510000</a>	BL 5.08/06/180 SN BK BX	PCB plug-in connector, female plug, 5.08 mm, No. of poles: 6, 180°, Leaf spring connection, Clamping range, max.: 2.08 mm <sup>2</sup> , Box	4008190376581	50 pc(s).	Box
<a href="#">1723870000</a>	BL 5.08/06/180 SN DKGN BX	PCB plug-in connector, female plug, 5.08 mm, No. of poles: 6, 180°, Leaf spring connection, Clamping range, max.: 2.08 mm <sup>2</sup> , Box	4008190376239	50 pc(s).	Box
<a href="#">1716360000</a>	BL 5.08/06/180 SN OR BX	PCB plug-in connector, female plug, 5.08 mm, No. of poles: 6, 180°, Leaf spring connection,	4008190376390	50 pc(s).	Box

## System pitch 5.08 mm (0.200 inch) SL-SMT 5.08/06/90G 3.2SN BK BX

**Weidmüller Interface GmbH & Co. KG**  
 Klingenbergstraße 16  
 D-32758 Detmold  
 Germany  
 Fon: +49 5231 14-0  
 Fax: +49 5231 14-2083  
 www.weidmueller.com

## Counterpart

Clamping range, max.: 2.08  
mm<sup>2</sup>, Box

### BLZ 5.00/180



Female connectors with clamping yoke screw connection for conductor connection with straight outlet direction. The female connectors provide space for labelling and can be coded. Packed in cardboard box.

- 0.20 - 2.5 mm<sup>2</sup> (IEC) / 26 - 12 AWG (UL)
- 400 V (IEC) / 300 V (UL)
- 19 A (IEC) / 15 A (UL)

### General ordering data

Order No.	Part designation	Version	GTIN (EAN)	Qty.	Packaging
<a href="#">1571390000</a>	BLZ 5.00/06/180 SN OR BX	PCB plug-in connector, female plug, 5.00 mm, No. of poles: 6, 180°, Clamping yoke connection, Clamping range, max.: 3.31 mm <sup>2</sup> , Box	4008190018795	50 pc(s).	Box
<a href="#">1596090000</a>	BLZ 5.00/06/180 SN BK BX	PCB plug-in connector, female plug, 5.00 mm, No. of poles: 6, 180°, Clamping yoke connection, Clamping range, max.: 3.31 mm <sup>2</sup> , Box	4008190034245	50 pc(s).	Box

### BLT 5.08



Female connectors with TOP screw system for connecting conductors with straight 180° outlet direction. The female connectors include space for labelling and can be coded. Packed in cardboard box.

- 0.20 - 2.5 mm<sup>2</sup> (IEC) / 26 - 14 AWG (UL)
- 400 V (IEC) / 300 V (UL)
- 17 A (IEC) / 10 A (UL)

### General ordering data

Order No.	Part designation	Version	GTIN (EAN)	Qty.	Packaging
<a href="#">1499910000</a>	BLT 5.08/06/180 SN BK BX	PCB plug-in connector, female plug, 5.08 mm, No. of poles: 6, 180°, TOP connection, Clamping range, max.: 2.5 mm <sup>2</sup> , Box	4008190279363	60 pc(s).	Box
<a href="#">1499960000</a>	BLT 5.08/06/180 SN OR BX	PCB plug-in connector, female plug, 5.08 mm, No. of poles: 6, 180°, TOP connection,	4008190140953	60 pc(s).	Box

## System pitch 5.08 mm (0.200 inch) SL-SMT 5.08/06/90G 3.2SN BK BX

**Weidmüller Interface GmbH & Co. KG**  
 Klingenbergstraße 16  
 D-32758 Detmold  
 Germany  
 Fon: +49 5231 14-0  
 Fax: +49 5231 14-2083  
 www.weidmueller.com

## Counterpart

Clamping range, max.: 2.5  
mm<sup>2</sup>, Box

### BLC 5.08R



Female connectors for conductor connection with crimp connection system. The female connectors provide space for labelling and can be coded. Packed in cardboard box.

- 0.25 - 2.5 mm<sup>2</sup> (IEC) / 26 - 14 AWG (UL)
- 400 V (IEC) / 300 V (UL)
- 21 A (IEC) / 10 A (UL)

### General ordering data

Order No.	Part designation	Version	GTIN (EAN)	Qty.	Packaging
<a href="#">1712000000</a>	BLC 5.08/06/180R BK BX	PCB plug-in connector, female plug, 5.08 mm, No. of poles: 6, 180°, Crimp connection, Clamping range, max.: 2.5 mm <sup>2</sup> , Box	4008190935016	50 pc(s).	Box
<a href="#">1610530000</a>	BLC 5.08/06/180R OR BX	PCB plug-in connector, female plug, 5.08 mm, No. of poles: 6, 180°, Crimp connection, Clamping range, max.: 2.5 mm <sup>2</sup> , Box	4008190123819	50 pc(s).	Box

### BLZ 5.08/180



Female connectors with clamping yoke screw connection for conductor connection with straight outlet direction. The female connectors provide space for labelling and can be coded. Packed in cardboard box.

- 0.20 - 2.5 mm<sup>2</sup> (IEC) / 26 - 12 AWG (UL)
- 400 V (IEC) / 300 V (UL)
- 19 A (IEC) / 15 A (UL)

### General ordering data

Order No.	Part designation	Version	GTIN (EAN)	Qty.	Packaging
<a href="#">1526810000</a>	BLZ 5.08/06/180 SN BK BX	PCB plug-in connector, female plug, 5.08 mm, No. of poles: 6, 180°, Clamping yoke connection, Clamping range, max.: 3.31 mm <sup>2</sup> , Box	4008190163891	50 pc(s).	Box
<a href="#">1526860000</a>	BLZ 5.08/06/180 SN OR BX	PCB plug-in connector, female plug, 5.08 mm, No. of poles: 6, 180°, Clamping yoke	4008190039448	50 pc(s).	Box



## System pitch 5.08 mm (0.200 inch) SL-SMT 5.08/06/90G 3.2SN BK BX

**Weidmüller Interface GmbH & Co. KG**  
 Klingenbergstraße 16  
 D-32758 Detmold  
 Germany  
 Fon: +49 5231 14-0  
 Fax: +49 5231 14-2083  
 www.weidmueller.com

## Counterpart

connection, Clamping range,  
 max.: 3.31 mm<sup>2</sup>, Box

### BLDT 5.08

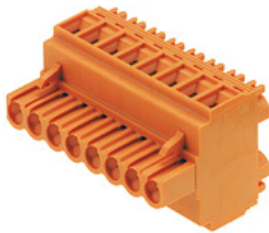

Female connectors with two clamping yoke screw connections per pole for conductor connection with 90° & 270° outlet direction. The female connectors provide space for labelling and can be coded. Packed in cardboard box.

- 0.20 - 2.5 mm<sup>2</sup> (IEC) / 26 - 12 AWG (UL)
- 400 V (IEC) / 300 V (UL)
- 14 A (IEC) / 10 A (UL)

#### General ordering data

Order No.	Part designation	Version	GTIN (EAN)	Qty.	Packaging
<a href="#">1644770000</a>	BLDT 5.08/06/- SN OR BX	PCB plug-in connector, female plug, 5.08 mm, No. of poles: 6, 90°/270°, Clamping yoke connection, Clamping range, max.: 3.31 mm <sup>2</sup> , Box	4008190283988	50 pc(s).	Box
<a href="#">1660750000</a>	BLDT 5.08/06/- SN BK BX	PCB plug-in connector, female plug, 5.08 mm, No. of poles: 6, 90°/270°, Clamping yoke connection, Clamping range, max.: 3.31 mm <sup>2</sup> , Box	4008190417208	50 pc(s).	Box

### BLZ 5.08/90

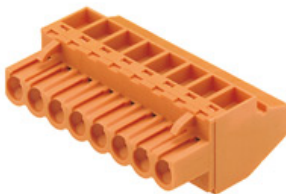

Female connectors with clamping yoke screw connection. The female connectors provide space for labelling and can be coded. Packed in cardboard box.

- 0.20 - 2.5 mm<sup>2</sup> (IEC) / 26 - 12 AWG (UL)
- 400 V (IEC) / 300 V (UL)
- 15 A (IEC) / 10 A (UL)

#### General ordering data

Order No.	Part designation	Version	GTIN (EAN)	Qty.	Packaging
<a href="#">1553160000</a>	BLZ 5.08/06/90 SN OR BX	PCB plug-in connector, female plug, 5.08 mm, No. of poles: 6, 90°, Clamping yoke connection, Clamping range, max.: 3.31 mm <sup>2</sup> , Box	4008190075804	60 pc(s).	Box
<a href="#">1553110000</a>	BLZ 5.08/06/90 SN BK BX	PCB plug-in connector, female plug, 5.08 mm, No. of poles: 6, 90°, Clamping yoke connection,	4008190267742	60 pc(s).	Box



## System pitch 5.08 mm (0.200 inch) SL-SMT 5.08/06/90G 3.2SN BK BX

**Weidmüller Interface GmbH & Co. KG**  
Klingenbergstraße 16  
D-32758 Detmold  
Germany  
Fon: +49 5231 14-0  
Fax: +49 5231 14-2083  
www.weidmueller.com

## Counterpart

Clamping range, max.: 3.31  
mm<sup>2</sup>, Box

### BLL 5.08/90



Female connector for PCB mounting. The solder pin length is optimised for wave flow soldering. Packed in cardboard box.

- 400 V (IEC) / 300 V (UL)
- 23 A (IEC) / 15 A (UL)

#### General ordering data

Order No.	Part designation	Version	GTIN (EAN)	Qty.	Packaging
<a href="#">1622980000</a>	BLL 5.08/06/90 3.2SN OR BX	PCB plug-in connector, female header, 5.08 mm, No. of poles: 6, 90°, Solder pin length: 3.2 mm, tinned, Orange, Solder connection, Box	4008190279301	50 pc(s).	Box

### BLZ 5.08/225



Female connectors with clamping yoke screw connection for conductor connection with 225° outlet direction. The female connectors provide space for labelling and can be coded. Packed in cardboard box.

- 0.20 - 2.5 mm<sup>2</sup> (IEC) / 26 - 12 AWG (UL)
- 400 V (IEC) / 300 V (UL)
- 16.5 A (IEC) / 10 A (UL)

#### General ordering data

Order No.	Part designation	Version	GTIN (EAN)	Qty.	Packaging
<a href="#">1741680000</a>	BLZ 5.08/06/225 SN OR BX	PCB plug-in connector, female plug, 5.08 mm, No. of poles: 6, 225°, Clamping yoke connection, Clamping range, max.: 3.31 mm <sup>2</sup> , Box	4008190215682	60 pc(s).	Box
<a href="#">1741910000</a>	BLZ 5.08/06/225 SN BK BX	PCB plug-in connector, female plug, 5.08 mm, No. of poles: 6, 225°, Clamping yoke connection, Clamping range, max.: 3.31 mm <sup>2</sup> , Box	4008190255763	60 pc(s).	Box

## System pitch 5.08 mm (0.200 inch) SL-SMT 5.08/06/90G 3.2SN BK BX

**Weidmüller Interface GmbH & Co. KG**  
 Klingenbergstraße 16  
 D-32758 Detmold  
 Germany  
 Fon: +49 5231 14-0  
 Fax: +49 5231 14-2083  
 www.weidmueller.com

## Counterpart

### BLZ 5.08/270



Female connectors with clamping yoke screw connection. The female connectors provide space for labelling and can be coded. Packed in cardboard box.

- 0.20 - 2.5 mm<sup>2</sup> (IEC) / 26 - 12 AWG (UL)
- 400 V (IEC) / 300 V (UL)
- 15 A (IEC) / 10 A (UL)

### General ordering data

Order No.	Part designation	Version	GTIN (EAN)	Qty.	Packaging
<a href="#">1557760000</a>	BLZ 5.08/06/270 SN OR BX	PCB plug-in connector, female plug, 5.08 mm, No. of poles: 6, 270°, Clamping yoke connection, Clamping range, max.: 3.31 mm <sup>2</sup> , Box	4008190145910	60 pc(s).	Box
<a href="#">1557710000</a>	BLZ 5.08/06/270 SN BK BX	PCB plug-in connector, female plug, 5.08 mm, No. of poles: 6, 270°, Clamping yoke connection, Clamping range, max.: 3.31 mm <sup>2</sup> , Box	4008190269463	60 pc(s).	Box

### BLZF 5.08/270



Female connectors for connecting conductors with tension clamp system. The female connectors include space for labelling and can be coded. Packed in cardboard box.

- 0.20 - 2.5 mm<sup>2</sup> (IEC) / 26 - 12 AWG (UL)
- 400 V (IEC) / 300 V (UL)
- 16.5 A (IEC) / 10 A (UL)

### General ordering data

Order No.	Part designation	Version	GTIN (EAN)	Qty.	Packaging
<a href="#">1672210000</a>	BLZF 5.08/06/270 SN BK BX	PCB plug-in connector, female plug, 5.08 mm, No. of poles: 6, 270°, Tension clamp connection, Clamping range, max.: 3.31 mm <sup>2</sup> , Box	4008190433925	60 pc(s).	Box
<a href="#">1671980000</a>	BLZF 5.08/06/270 SN OR BX	PCB plug-in connector, female plug, 5.08 mm, No. of poles: 6, 270°, Tension clamp connection, Clamping range, max.: 3.31 mm <sup>2</sup> , Box	4008190433697	60 pc(s).	Box

## System pitch 5.08 mm (0.200 inch) SL-SMT 5.08/06/90G 3.2SN BK BX

**Weidmüller Interface GmbH & Co. KG**  
 Klingenbergstraße 16  
 D-32758 Detmold  
 Germany  
 Fon: +49 5231 14-0  
 Fax: +49 5231 14-2083  
 www.weidmueller.com

## Counterpart

### BLZP 5.08/270F SN



Socket connectors with clamping yoke screw connection for conductor connection with a right-angle (90° or 270°) outlet direction. The female connectors provide space for labelling and can be coded. Can be fastened with flange or release latch. They feature an integrated plus/minus screw, protection against false insertion under clamping yoke. They are delivered with an opened clamping yoke.

- 0.2-2.5 mm<sup>2</sup> (IEC) / 26-12 AWG (UL)
- 400 V (IEC) / 300 V (UL)
- 15 A (IEC) / 10 A (UL)

#### General ordering data

Order No.	Part designation	Version	GTIN (EAN)	Qty.	Packaging
<a href="#">1950350000</a>	BLZP 5.08/06/270F SN OR BX	PCB plug-in connector, female plug, 5.08 mm, No. of poles: 6, 270°, Clamping yoke connection, Clamping range, max.: 4 mm <sup>2</sup> , Box	4032248628476	42 pc(s).	Box
<a href="#">1950620000</a>	BLZP 5.08/06/270F SN BK BX	PCB plug-in connector, female plug, 5.08 mm, No. of poles: 6, 270°, Clamping yoke connection, Clamping range, max.: 4 mm <sup>2</sup> , Box	4032248628896	42 pc(s).	Box

### BLZP 5.08/180F SN



Female connectors with clamping yoke screw connection for conductor connection with straight (180°) outlet direction. The female connectors provide space for labelling and can be coded. Can be fastened with flange or release latch. They feature an integrated plus/minus screw, protection against false insertion under clamping yoke. They are delivered with an opened clamping yoke.

- 0.2-2.5 mm<sup>2</sup> (IEC) / 26-12 AWG (UL)
- 400 V (IEC) / 300 V (UL)
- 19 A (IEC) / 15 A (UL)

#### General ordering data

Order No.	Part designation	Version	GTIN (EAN)	Qty.	Packaging
<a href="#">1944130000</a>	BLZP 5.08/06/180F SN OR BX	PCB plug-in connector, female plug, 5.08 mm, No. of poles: 6, 180°, Clamping yoke connection, Clamping range, max.: 4 mm <sup>2</sup> , Box	4032248618712	45 pc(s).	Box
<a href="#">1944370000</a>	BLZP 5.08/06/180F SN BK BX	PCB plug-in connector, female plug, 5.08 mm, No. of poles: 6, 180°, Clamping yoke connection, Clamping range, max.: 4 mm <sup>2</sup> , Box	4032248618941	45 pc(s).	Box

## System pitch 5.08 mm (0.200 inch) SL-SMT 5.08/06/90G 3.2SN BK BX

**Weidmüller Interface GmbH & Co. KG**  
 Klingenbergstraße 16  
 D-32758 Detmold  
 Germany  
 Fon: +49 5231 14-0  
 Fax: +49 5231 14-2083  
 www.weidmueller.com

## Counterpart

### BLZP 5.00/270F SN

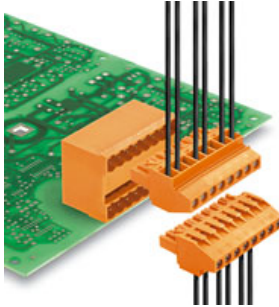

Socket connectors with clamping yoke screw connection for conductor connection with a right-angle (90° or 270°) outlet direction. The female connectors provide space for labelling and can be coded. Can be fastened with flange or release latch. They feature an integrated plus/minus screw, protection against false insertion under clamping yoke. They are delivered with an opened clamping yoke.

- 0.2-2.5 mm<sup>2</sup> (IEC) / 26-12 AWG (UL)
- 400 V (IEC) / 300 V (UL)
- 15 A (IEC) / 10 A (UL)

#### General ordering data

Order No.	Part designation	Version	GTIN (EAN)	Qty.	Packaging
<a href="#">1960690000</a>	BLZP 5.00/06/270F SN BK BX	PCB plug-in connector, female plug, 5.00 mm, No. of poles: 6, 90°, Clamping yoke connection, Clamping range, max.: 4 mm <sup>2</sup> , Box	4032248639489	42 pc(s).	Box
<a href="#">1960420000</a>	BLZP 5.00/06/270F SN OR BX	PCB plug-in connector, female plug, 5.00 mm, No. of poles: 6, 90°, Clamping yoke connection, Clamping range, max.: 4 mm <sup>2</sup> , Box	4032248639281	42 pc(s).	Box

### BLZ 5.00/90B

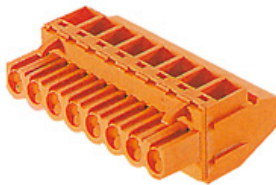

Female connectors with clamping yoke screw connection. The female connectors provide space for labelling and can be coded. Packed in cardboard box.

- 0.20 - 2.5 mm<sup>2</sup> (IEC) / 26 - 12 AWG (UL)
- 400 V (IEC) / 300 V (UL)
- 15 A (IEC) / 10 A (UL)

#### General ordering data

Order No.	Part designation	Version	GTIN (EAN)	Qty.	Packaging
<a href="#">1637160000</a>	BLZ 5.00/06/90B SN OR BX	PCB plug-in connector, female plug, 5.00 mm, No. of poles: 6, 90°, Clamping yoke connection, Clamping range, max.: 3.31 mm <sup>2</sup> , Box	4008190274405	54 pc(s).	Box

## System pitch 5.08 mm (0.200 inch) SL-SMT 5.08/06/90G 3.2SN BK BX

**Weidmüller Interface GmbH & Co. KG**  
Klingenbergstraße 16  
D-32758 Detmold  
Germany  
Fon: +49 5231 14-0  
Fax: +49 5231 14-2083  
www.weidmueller.com

## Counterpart

### BLZ 5.08/180LH



Socket connectors with clamping yoke screw connection for conductor connection with 270° outlet direction and release lever or release latch mechanism. The female connectors provide space for labelling and can be coded. Packed in cardboard box.br/>

- 0.20–1.5 mm<sup>2</sup> (IEC) / 26–12 AWG (UL)
- 400 V (IEC) / 300 V (UL)
- 19 A (IEC) / 15 A (UL)

### General ordering data

Order No.	Part designation	Version	GTIN (EAN)	Qty.	Packaging
<a href="#">1893640000</a>	BLZ 5.08/06/180LH SN BK BX	PCB plug-in connector, female plug, 5.08 mm, No. of poles: 6, 180°, Clamping yoke connection, Clamping range, max.: 3.31 mm <sup>2</sup> , Box	4032248507825	50 pc(s).	Box
<a href="#">1892230000</a>	BLZ 5.08/06/180LH SN OR BX	PCB plug-in connector, female plug, 5.08 mm, No. of poles: 6, 180°, Clamping yoke connection, Clamping range, max.: 3.31 mm <sup>2</sup> , Box	4032248505630	50 pc(s).	Box

### BLZP 5.08/90F SN

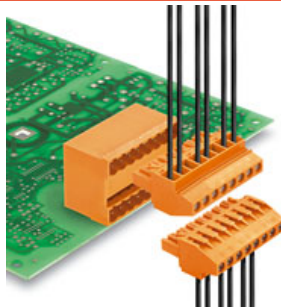

Socket connectors with clamping yoke screw connection for conductor connection with a right-angle (90° or 270°) outlet direction. The female connectors provide space for labelling and can be coded. Can be fastened with flange or release latch. They feature an integrated plus/minus screw, protection against false insertion under clamping yoke. They are delivered with an opened clamping yoke.

- 0.2-2.5 mm<sup>2</sup> (IEC) / 26-12 AWG (UL)
- 400 V (IEC) / 300 V (UL)
- 15 A (IEC) / 10 A (UL)

### General ordering data

Order No.	Part designation	Version	GTIN (EAN)	Qty.	Packaging
<a href="#">1949840000</a>	BLZP 5.08/06/90F SN OR BX	PCB plug-in connector, female plug, 5.08 mm, No. of poles: 6, 90°, Clamping yoke connection, Clamping range, max.: 4 mm <sup>2</sup> , Box	4032248627769	42 pc(s).	Box
<a href="#">1950080000</a>	BLZP 5.08/06/90F SN BK BX	PCB plug-in connector, female plug, 5.08 mm, No. of poles: 6, 90°, Clamping yoke connection, Clamping range, max.: 4 mm <sup>2</sup> , Box	4032248628018	42 pc(s).	Box

## System pitch 5.08 mm (0.200 inch) SL-SMT 5.08/06/90G 3.2SN BK BX

**Weidmüller Interface GmbH & Co. KG**  
 Klingenbergstraße 16  
 D-32758 Detmold  
 Germany  
 Fon: +49 5231 14-0  
 Fax: +49 5231 14-2083  
 www.weidmueller.com

## Counterpart

### BLZP 5.00/180F SN



Female connectors with clamping yoke screw connection for conductor connection with straight (180°) outlet direction. The female connectors provide space for labelling and can be coded. Can be fastened with flange or release latch. They feature an integrated plus/minus screw, protection against false insertion under clamping yoke. They are delivered with an opened clamping yoke.

- 0.2-2.5 mm<sup>2</sup> (IEC) / 26-12 AWG (UL)
- 400 V (IEC) / 300 V (UL)
- 19 A (IEC) / 15 A (UL)

#### General ordering data

Order No.	Part designation	Version	GTIN (EAN)	Qty.	Packaging
<a href="#">1955760000</a>	BLZP 5.00/06/180F SN OR BX	PCB plug-in connector, female plug, 5.00 mm, No. of poles: 6, 180°, Clamping yoke connection, Clamping range, max.: 4 mm <sup>2</sup> , Box	4032248634309	45 pc(s).	Box
<a href="#">1955990000</a>	BLZP 5.00/06/180F SN BK BX	PCB plug-in connector, female plug, 5.00 mm, No. of poles: 6, 180°, Clamping yoke connection, Clamping range, max.: 4 mm <sup>2</sup> , Box	4032248634569	45 pc(s).	Box

### BLZP 5.00/270LH SN



Socket connectors with clamping yoke screw connection for conductor connection with a right-angle (90° or 270°) outlet direction. The female connectors provide space for labelling and can be coded. Can be fastened with flange or release latch. They feature an integrated plus/minus screw, protection against false insertion under clamping yoke. They are delivered with an opened clamping yoke.

- 0.2-2.5 mm<sup>2</sup> (IEC) / 26-12 AWG (UL)
- 400 V (IEC) / 300 V (UL)
- 15 A (IEC) / 10 A (UL)

#### General ordering data

Order No.	Part designation	Version	GTIN (EAN)	Qty.	Packaging
<a href="#">1961400000</a>	BLZP 5.00/06/270LH SN OR BX	PCB plug-in connector, female plug, 5.00 mm, No. of poles: 6, 90°, Clamping yoke connection, Clamping range, max.: 4 mm <sup>2</sup> , Box	4032248640676	42 pc(s).	Box
<a href="#">1961630000</a>	BLZP 5.00/06/270LH SN BK BX	PCB plug-in connector, female plug, 5.00 mm, No. of poles: 6, 90°, Clamping yoke connection, Clamping range, max.: 4 mm <sup>2</sup> , Box	4032248640904	42 pc(s).	Box

**System pitch 5.08 mm (0.200 inch)  
SL-SMT 5.08/06/90G 3.2SN BK BX**

**Weidmüller Interface GmbH & Co. KG**  
Klingenbergstraße 16  
D-32758 Detmold  
Germany  
Fon: +49 5231 14-0  
Fax: +49 5231 14-2083  
www.weidmueller.com

**Counterpart**
**BLZ 5.08/180F**

Female connectors with clamping yoke screw connection for conductor connection with straight outlet direction. The female connectors provide space for labelling and can be coded. Packed in cardboard box.

- 0.20 - 2.5 mm<sup>2</sup> (IEC) / 26 - 12 AWG (UL)
- 400 V (IEC) / 300 V (UL)
- 19 A (IEC) / 15 A (UL)

**General ordering data**

Order No.	Part designation	Version	GTIN (EAN)	Qty.	Packaging
<a href="#">1802870000</a>	BLZ 5.08/06/180F SN OR BX	PCB plug-in connector, female plug, 5.08 mm, No. of poles: 6, 180°, Clamping yoke connection, Clamping range, max.: 3.31 mm <sup>2</sup> , Box	4032248257942	50 pc(s).	Box
<a href="#">1803080000</a>	BLZ 5.08/06/180F SN BK BX	PCB plug-in connector, female plug, 5.08 mm, No. of poles: 6, 180°, Clamping yoke connection, Clamping range, max.: 3.31 mm <sup>2</sup> , Box	4032248258185	50 pc(s).	Box

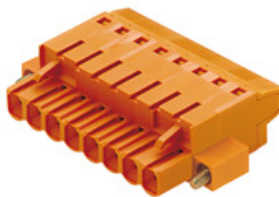
**BLT 5.08F**

Female connectors with TOP screw system for connecting conductors with straight 180° outlet direction. The female connectors include space for labelling and can be coded. Packed in cardboard box.

- 0.20 - 2.5 mm<sup>2</sup> (IEC) / 26 - 14 AWG (UL)
- 400 V (IEC) / 300 V (UL)
- 17 A (IEC) / 10 A (UL)

**General ordering data**

Order No.	Part designation	Version	GTIN (EAN)	Qty.	Packaging
<a href="#">1844030000</a>	BLT 5.08/06/180F SN OR BX	PCB plug-in connector, female plug, 5.08 mm, No. of poles: 6, 180°, TOP connection, Clamping range, max.: 2.5 mm <sup>2</sup> , Box	4032248355952	50 pc(s).	Box
<a href="#">1844260000</a>	BLT 5.08/06/180F SN BK BX	PCB plug-in connector, female plug, 5.08 mm, No. of poles: 6, 180°, TOP connection, Clamping range, max.: 2.5 mm <sup>2</sup> , Box	4032248356195	42 pc(s).	Box



## System pitch 5.08 mm (0.200 inch) SL-SMT 5.08/06/90G 3.2SN BK BX

**Weidmüller Interface GmbH & Co. KG**  
 Klingenbergstraße 16  
 D-32758 Detmold  
 Germany  
 Fon: +49 5231 14-0  
 Fax: +49 5231 14-2083  
 www.weidmueller.com

## Counterpart

### BLL 5.08/90FI



Female connector for PCB mounting. The solder pin length is optimised for wave flow soldering. Packed in cardboard box.

- 400 V (IEC) / 300 V (UL)
- 23 A (IEC) / 15 A (UL)

### General ordering data

Order No.	Part designation	Version	GTIN (EAN)	Qty.	Packaging
<a href="#">1843790000</a>	BLL 5.08/06/90FI 3.2SN OR BX	PCB plug-in connector, female header, 5.08 mm, No. of poles: 6, 90°, Solder pin length: 3.2 mm, tinned, Orange, Solder connection, Box	4032248355549	50 pc(s).	Box

### BLF 5.08/90LH SN



Just as reliable as the tried-and-true original, with innovation in detail:

The BLF 5.0x – the PUSH-IN version of the BLZ 5.0x socket block – features a new connection system and a more compact design. Weidmüller's innovative PUSH-IN spring connection features a trend-setting, tool-free wire connection system that is simple to operate.

In terms of versatility, the BLF 5.0x offers just as much as the older versions:

- The choice of three wire outlet directions offers you proven design flexibility for your applications.
- Four flange variations, including the patented release latch, allow for user-friendly unplugging designs.

### General ordering data

Order No.	Part designation	Version	GTIN (EAN)	Qty.	Packaging
<a href="#">1002520000</a>	BLF 5.08/06/90LH SN OR BX	PCB plug-in connector, female plug, 5.08 mm, No. of poles: 6, 90°, PUSH IN, Clamping range, max.: 3.31 mm², Box	4032248694891	42 pc(s).	Box
<a href="#">1000680001</a>	BLF 5.08/06/90LH SN BK BX	PCB plug-in connector, female plug, 5.08 mm, No. of poles: 6, 90°, PUSH IN, Clamping range, max.: 3.31 mm², Box	4032248690879	42 pc(s).	Box



## System pitch 5.08 mm (0.200 inch) SL-SMT 5.08/06/90G 3.2SN BK BX

**Weidmüller Interface GmbH & Co. KG**  
 Klingenbergstraße 16  
 D-32758 Detmold  
 Germany  
 Fon: +49 5231 14-0  
 Fax: +49 5231 14-2083  
 www.weidmueller.com

## Counterpart

### BLZP 5.00/180LR SN



Female connectors with clamping yoke screw connection for conductor connection with straight (180°) outlet direction. The female connectors provide space for labelling and can be coded. Can be fastened with flange or release latch. They feature an integrated plus/minus screw, protection against false insertion under clamping yoke. They are delivered with an opened clamping yoke.

- 0.2-2.5 mm<sup>2</sup> (IEC) / 26-12 AWG (UL)
- 400 V (IEC) / 300 V (UL)
- 19 A (IEC) / 15 A (UL)

#### General ordering data

Order No.	Part designation	Version	GTIN (EAN)	Qty.	Packaging
<a href="#">1956560000</a>	BLZP 5.00/06/180LR SN BK BX	PCB plug-in connector, female plug, 5.00 mm, No. of poles: 6, 180°, Clamping yoke connection, Clamping range, max.: 4 mm <sup>2</sup> , Box	4032248635368	45 pc(s).	Box
<a href="#">1956330000</a>	BLZP 5.00/06/180LR SN OR BX	PCB plug-in connector, female plug, 5.00 mm, No. of poles: 6, 180°, Clamping yoke connection, Clamping range, max.: 4 mm <sup>2</sup> , Box	4032248635030	45 pc(s).	Box

### BLZ 5.00/180F



Female connectors with clamping yoke screw connection for conductor connection with straight outlet direction. The female connectors provide space for labelling and can be coded. Packed in cardboard box.

- 0.20 - 2.5 mm<sup>2</sup> (IEC) / 26 - 12 AWG (UL)
- 400 V (IEC) / 300 V (UL)
- 19 A (IEC) / 15 A (UL)

#### General ordering data

Order No.	Part designation	Version	GTIN (EAN)	Qty.	Packaging
<a href="#">1843330000</a>	BLZ 5.00/06/180F SN OR BX	PCB plug-in connector, female plug, 5.00 mm, No. of poles: 6, 180°, Clamping yoke connection, Clamping range, max.: 3.31 mm <sup>2</sup> , Box	4032248355051	50 pc(s).	Box
<a href="#">1843560000</a>	BLZ 5.00/06/180F SN BK BX	PCB plug-in connector, female plug, 5.00 mm, No. of poles: 6, 180°, Clamping yoke connection, Clamping range, max.: 3.31 mm <sup>2</sup> , Box	4032248355280	50 pc(s).	Box

## System pitch 5.08 mm (0.200 inch) SL-SMT 5.08/06/90G 3.2SN BK BX

**Weidmüller Interface GmbH & Co. KG**  
 Klingenbergstraße 16  
 D-32758 Detmold  
 Germany  
 Fon: +49 5231 14-0  
 Fax: +49 5231 14-2083  
 www.weidmueller.com

## Counterpart

### BLDT 5.08B



Female connectors with two clamping yoke screw connections per pole for conductor connection with 90° & 270° outlet direction. The female connectors provide space for labelling and can be coded. Packed in cardboard box.

- 0.20 - 2.5 mm<sup>2</sup> (IEC) / 26 - 12 AWG (UL)
- 400 V (IEC) / 300 V (UL)
- 14 A (IEC) / 10 A (UL)

### General ordering data

Order No.	Part designation	Version	GTIN (EAN)	Qty.	Packaging
<a href="#">1651780000</a>	BLDT 5.08/06/-B SN OR BX	PCB plug-in connector, female plug, 5.08 mm, No. of poles: 6, 90°/270°, Clamping yoke connection, Clamping range, max.: 3.31 mm <sup>2</sup> , Box	4008190400460	50 pc(s).	Box
<a href="#">1673820000</a>	BLDT 5.08/06/-B SN BK BX	PCB plug-in connector, female plug, 5.08 mm, No. of poles: 6, 90°/270°, Clamping yoke connection, Clamping range, max.: 3.31 mm <sup>2</sup> , Box	4008190435554	50 pc(s).	Box

### BLZP 5.08/180LH SN



Female connectors with clamping yoke screw connection for conductor connection with straight (180°) outlet direction. The female connectors provide space for labelling and can be coded. Can be fastened with flange or release latch. They feature an integrated plus/minus screw, protection against false insertion under clamping yoke. They are delivered with an opened clamping yoke.

- 0.2-2.5 mm<sup>2</sup> (IEC) / 26-12 AWG (UL)
- 400 V (IEC) / 300 V (UL)
- 19 A (IEC) / 15 A (UL)

### General ordering data

Order No.	Part designation	Version	GTIN (EAN)	Qty.	Packaging
<a href="#">1945330000</a>	BLZP 5.08/06/180LH SN OR BX	PCB plug-in connector, female plug, 5.08 mm, No. of poles: 6, 180°, Clamping yoke connection, Clamping range, max.: 4 mm <sup>2</sup> , Box	4032248619900	45 pc(s).	Box
<a href="#">1945560000</a>	BLZP 5.08/06/180LH SN BK BX	PCB plug-in connector, female plug, 5.08 mm, No. of poles: 6, 180°, Clamping yoke connection, Clamping range, max.: 4 mm <sup>2</sup> , Box	4032248620739	45 pc(s).	Box

## System pitch 5.08 mm (0.200 inch) SL-SMT 5.08/06/90G 3.2SN BK BX

**Weidmüller Interface GmbH & Co. KG**  
 Klingenbergstraße 16  
 D-32758 Detmold  
 Germany  
 Fon: +49 5231 14-0  
 Fax: +49 5231 14-2083  
 www.weidmueller.com

## Counterpart

### BLZ 5.08/90B

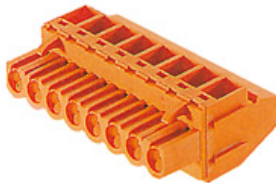

Female connectors with clamping yoke screw connection. The female connectors provide space for labelling and can be coded. Packed in cardboard box.

- 0.20 - 2.5 mm<sup>2</sup> (IEC) / 26 - 12 AWG (UL)
- 400 V (IEC) / 300 V (UL)
- 15 A (IEC) / 10 A (UL)

### General ordering data

Order No.	Part designation	Version	GTIN (EAN)	Qty.	Packaging
<a href="#">1555460000</a>	BLZ 5.08/06/90B SN OR BX	PCB plug-in connector, female plug, 5.08 mm, No. of poles: 6, 90°, Clamping yoke connection, Clamping range, max.: 3.31 mm <sup>2</sup> , Box	4008190012830	54 pc(s).	Box

### BLC 5.08BR

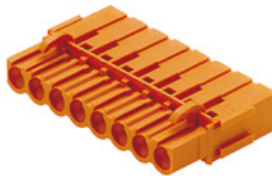

Female connectors for conductor connection with crimp connection system. The female connectors provide space for labelling and can be coded. Packed in cardboard box.

- 0.25 - 2.5 mm<sup>2</sup> (IEC) / 26 - 14 AWG (UL)
- 400 V (IEC) / 300 V (UL)
- 21 A (IEC) / 10 A (UL)

### General ordering data

Order No.	Part designation	Version	GTIN (EAN)	Qty.	Packaging
<a href="#">1649410000</a>	BLC 5.08/06/180BR OR BX	PCB plug-in connector, female plug, 5.08 mm, No. of poles: 6, 180°, Crimp connection, Clamping range, max.: 2.5 mm <sup>2</sup> , Box	4008190294526	50 pc(s).	Box
<a href="#">1712150000</a>	BLC 5.08/06/180BR BK BX	PCB plug-in connector, female plug, 5.08 mm, No. of poles: 6, 180°, Crimp connection, Clamping range, max.: 2.5 mm <sup>2</sup> , Box	4008190935160	50 pc(s).	Box

## System pitch 5.08 mm (0.200 inch) SL-SMT 5.08/06/90G 3.2SN BK BX

**Weidmüller Interface GmbH & Co. KG**  
Klingenbergstraße 16  
D-32758 Detmold  
Germany  
Fon: +49 5231 14-0  
Fax: +49 5231 14-2083  
www.weidmueller.com

# Counterpart

### BLF 5.08/90LR SN



Just as reliable as the tried-and-true original, with innovation in detail:

The BLF 5.0x – the PUSH-IN version of the BLZ 5.0x socket block – features a new connection system and a more compact design. Weidmüller's innovative PUSH-IN spring connection features a trend-setting, tool-free wire connection system that is simple to operate.

In terms of versatility, the BLF 5.0x offers just as much as the older versions:

- The choice of three wire outlet directions offers you proven design flexibility for your applications.
- Four flange variations, including the patented release latch, allow for user-friendly unplugging designs.

### General ordering data

Order No.	Part designation	Version	GTIN (EAN)	Qty.	Packaging
<a href="#">1002320000</a>	BLF 5.08/06/90LR SN OR BX	PCB plug-in connector, female plug, 5.08 mm, No. of poles: 6, 90°, PUSH IN, Clamping range, max.: 3.31 mm², Box	4032248694488	42 pc(s).	Box
<a href="#">1000450001</a>	BLF 5.08/06/90LR SN BK BX	PCB plug-in connector, female plug, 5.08 mm, No. of poles: 6, 90°, PUSH IN, Clamping range, max.: 3.31 mm², Box	4032248690411	42 pc(s).	Box

### BLL 5.08/180B

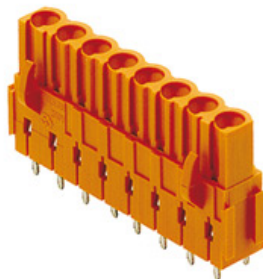

Female connector for PCB mounting. The solder pin length is optimised for wave flow soldering. Packed in cardboard box.

- 400 V (IEC) / 300 V (UL)
- 23 A (IEC) / 15 A (UL)

### General ordering data

Order No.	Part designation	Version	GTIN (EAN)	Qty.	Packaging
<a href="#">1682770000</a>	BLL 5.08/06/180B 3.2SN OR BX	PCB plug-in connector, female header, 5.08 mm, No. of poles: 6, 180°, Solder pin length: 3.2 mm, tinned, Orange, Solder connection, Box	4008190474539	50 pc(s).	Box

## System pitch 5.08 mm (0.200 inch) SL-SMT 5.08/06/90G 3.2SN BK BX

**Weidmüller Interface GmbH & Co. KG**  
 Klingenbergstraße 16  
 D-32758 Detmold  
 Germany  
 Fon: +49 5231 14-0  
 Fax: +49 5231 14-2083  
 www.weidmueller.com

## Counterpart

### BLZP 5.08/270LR SN



Socket connectors with clamping yoke screw connection for conductor connection with a right-angle (90° or 270°) outlet direction. The female connectors provide space for labelling and can be coded. Can be fastened with flange or release latch. They feature an integrated plus/minus screw, protection against false insertion under clamping yoke. They are delivered with an opened clamping yoke.

- 0.2-2.5 mm<sup>2</sup> (IEC) / 26-12 AWG (UL)
- 400 V (IEC) / 300 V (UL)
- 15 A (IEC) / 10 A (UL)

#### General ordering data

Order No.	Part designation	Version	GTIN (EAN)	Qty.	Packaging
<a href="#">1947570000</a>	BLZP 5.08/06/270LR SN OR BX	PCB plug-in connector, female plug, 5.08 mm, No. of poles: 6, 270°, Clamping yoke connection, Clamping range, max.: 4 mm <sup>2</sup> , Box	4032248623860	42 pc(s).	Box
<a href="#">1947800000</a>	BLZP 5.08/06/270LR SN BK BX	PCB plug-in connector, female plug, 5.08 mm, No. of poles: 6, 270°, Clamping yoke connection, Clamping range, max.: 4 mm <sup>2</sup> , Box	4032248624195	42 pc(s).	Box

### BLZ 5.00/270B



Female connectors with clamping yoke screw connection. The female connectors provide space for labelling and can be coded. Packed in cardboard box.

- 0.20 - 2.5 mm<sup>2</sup> (IEC) / 26 - 12 AWG (UL)
- 400 V (IEC) / 300 V (UL)
- 15 A (IEC) / 10 A (UL)

#### General ordering data

Order No.	Part designation	Version	GTIN (EAN)	Qty.	Packaging
<a href="#">1638310000</a>	BLZ 5.00/06/270B SN BK BX	PCB plug-in connector, female plug, 5.00 mm, No. of poles: 6, 270°, Clamping yoke connection, Clamping range, max.: 3.31 mm <sup>2</sup> , Box	4008190275570	54 pc(s).	Box
<a href="#">1638080000</a>	BLZ 5.00/06/270B SN OR BX	PCB plug-in connector, female plug, 5.00 mm, No. of poles: 6, 270°, Clamping yoke connection, Clamping range, max.: 3.31 mm <sup>2</sup> , Box	4008190275341	54 pc(s).	Box

**System pitch 5.08 mm (0.200 inch)  
SL-SMT 5.08/06/90G 3.2SN BK BX**

**Weidmüller Interface GmbH & Co. KG**  
Klingenbergstraße 16  
D-32758 Detmold  
Germany  
Fon: +49 5231 14-0  
Fax: +49 5231 14-2083  
www.weidmueller.com

**Counterpart**
**BLZF 5.08/180F**

Female connectors for connecting conductors with tension clamp system, straight 180° outlet direction. The female connectors include space for labelling and can be coded. Packed in cardboard box.

- 0.20 - 2.5 mm<sup>2</sup> (IEC) / 26 - 12 AWG (UL)
- 400 V (IEC) / 300 V (UL)
- 17 A (IEC) / 15 A (UL)

**General ordering data**

Order No.	Part designation	Version	GTIN (EAN)	Qty.	Packaging
<a href="#">1803600000</a>	BLZF 5.08/06/180F SN BK BX	PCB plug-in connector, female plug, 5.08 mm, No. of poles: 6, 180°, Tension clamp connection, Clamping range, max.: 3.31 mm <sup>2</sup> , Box	4032248259007	42 pc(s).	Box
<a href="#">1803370000</a>	BLZF 5.08/06/180F SN OR BX	PCB plug-in connector, female plug, 5.08 mm, No. of poles: 6, 180°, Tension clamp connection, Clamping range, max.: 3.31 mm <sup>2</sup> , Box	4032248258772	42 pc(s).	Box

**BLZF 5.08/180LH**

Socket blocks for conductor connection, featuring the time-saving tension clamp technology, with straight outlet direction and release lever or release latch mechanism. The female connectors provide space for labelling and can be coded. Packed in cardboard box.

- 0.20 - 1.5 mm<sup>2</sup> (IEC) / 26 - 12 AWG (UL)
- 400 V (IEC) / 300 V (UL)
- 17 A (IEC) / 15 A (UL)

**General ordering data**

Order No.	Part designation	Version	GTIN (EAN)	Qty.	Packaging
<a href="#">1895760000</a>	BLZF 5.08/06/180LH SN OR BX	PCB plug-in connector, female plug, 5.08 mm, No. of poles: 6, 180°, Tension clamp connection, Clamping range, max.: 3.31 mm <sup>2</sup> , Box	4032248510481	42 pc(s).	Box
<a href="#">1893200000</a>	BLZF 5.08/06/180LH SN BK BX	PCB plug-in connector, female plug, 5.08 mm, No. of poles: 6, 180°, Tension clamp connection, Clamping range, max.: 3.31 mm <sup>2</sup> , Box	4032248507344	42 pc(s).	Box

## System pitch 5.08 mm (0.200 inch) SL-SMT 5.08/06/90G 3.2SN BK BX

**Weidmüller Interface GmbH & Co. KG**  
 Klingenbergstraße 16  
 D-32758 Detmold  
 Germany  
 Fon: +49 5231 14-0  
 Fax: +49 5231 14-2083  
 www.weidmueller.com

## Counterpart

### BLT 5.08LR



Socket connectors with clamping yoke screw connection for conductor connection with 270° outlet direction and release lever or release latch mechanism. The female connectors provide space for labelling and can be coded. Packed in cardboard box.

- 0.20 - 1.5 mm<sup>2</sup> (IEC) / 26 - 14 AWG (UL)
- 400 V (IEC) / 300 V (UL)
- 17 A (IEC) / 10 A (UL)

### General ordering data

Order No.	Part designation	Version	GTIN (EAN)	Qty.	Packaging
<a href="#">1890260000</a>	BLT 5.08/06/180LR SN OR BX	PCB plug-in connector, female plug, 5.08 mm, No. of poles: 6, 180°, TOP connection, Clamping range, max.: 2.5 mm <sup>2</sup> , Box	4032248498741	42 pc(s).	Box
<a href="#">1894170000</a>	BLT 5.08/06/180LR SN BK BX	PCB plug-in connector, female plug, 5.08 mm, No. of poles: 6, 180°, TOP connection, Clamping range, max.: 2.5 mm <sup>2</sup> , Box	4032248508518	42 pc(s).	Box

### BLF 5.00/90LH SN



Just as reliable as the tried-and-true original, with innovation in detail:

The BLF 5.0x – the PUSH-IN version of the BLZ 5.0x socket block – features a new connection system and a more compact design. Weidmüller's innovative PUSH-IN spring connection features a trend-setting, tool-free wire connection system that is simple to operate.

In terms of versatility, the BLF 5.0x offers just as much as the older versions:

- The choice of three wire outlet directions offers you proven design flexibility for your applications.
- Four flange variations, including the patented release latch, allow for user-friendly unplugging designs.

### General ordering data

Order No.	Part designation	Version	GTIN (EAN)	Qty.	Packaging
<a href="#">1981410000</a>	BLF 5.00/06/90LH SN OR BX	PCB plug-in connector, female plug, 5.00 mm, No. of poles: 6, 90°, PUSH IN, Clamping range, max.: 3.31 mm <sup>2</sup> , Box	4032248676712	42 pc(s).	Box
<a href="#">1980020000</a>	BLF 5.00/06/90LH SN BK BX	PCB plug-in connector, female plug, 5.00 mm, No. of poles: 6, 90°, PUSH IN, Clamping range, max.: 3.31 mm <sup>2</sup> , Box	4032248675081	42 pc(s).	Box



## System pitch 5.08 mm (0.200 inch) SL-SMT 5.08/06/90G 3.2SN BK BX

**Weidmüller Interface GmbH & Co. KG**  
Klingenbergstraße 16  
D-32758 Detmold  
Germany  
Fon: +49 5231 14-0  
Fax: +49 5231 14-2083  
www.weidmueller.com

## Counterpart

### BLZ 5.08/180LR



Socket connectors with clamping yoke screw connection for conductor connection with 270° outlet direction and release lever or release latch mechanism. The female connectors provide space for labelling and can be coded. Packed in cardboard box.

- 0.20 - 1.5 mm<sup>2</sup> (IEC) / 26 - 12 AWG (UL)
- 400 V (IEC) / 300 V (UL)
- 19 A (IEC) / 15 A (UL)

### General ordering data

Order No.	Part designation	Version	GTIN (EAN)	Qty.	Packaging
<a href="#">1851240000</a>	BLZ 5.08/06/180LR SN OR BX	PCB plug-in connector, female plug, 5.08 mm, No. of poles: 6, 180°, Clamping yoke connection, Clamping range, max.: 3.31 mm <sup>2</sup> , Box	4032248382613	50 pc(s).	Box
<a href="#">1892990000</a>	BLZ 5.08/06/180LR SN BK BX	PCB plug-in connector, female plug, 5.08 mm, No. of poles: 6, 180°, Clamping yoke connection, Clamping range, max.: 3.31 mm <sup>2</sup> , Box	4032248507139	50 pc(s).	Box

### BLZP 5.00/270LR SN



Socket connectors with clamping yoke screw connection for conductor connection with a right-angle (90° or 270°) outlet direction. The female connectors provide space for labelling and can be coded. Can be fastened with flange or release latch. They feature an integrated plus/minus screw, protection against false insertion under clamping yoke. They are delivered with an opened clamping yoke.

- 0.2-2.5 mm<sup>2</sup> (IEC) / 26-12 AWG (UL)
- 400 V (IEC) / 300 V (UL)
- 15 A (IEC) / 10 A (UL)

### General ordering data

Order No.	Part designation	Version	GTIN (EAN)	Qty.	Packaging
<a href="#">1961150000</a>	BLZP 5.00/06/270LR SN BK BX	PCB plug-in connector, female plug, 5.00 mm, No. of poles: 6, 90°, Clamping yoke connection, Clamping range, max.: 4 mm <sup>2</sup> , Box	4032248640225	42 pc(s).	Box
<a href="#">1960920000</a>	BLZP 5.00/06/270LR SN OR BX	PCB plug-in connector, female plug, 5.00 mm, No. of poles: 6, 90°, Clamping yoke connection, Clamping range, max.: 4 mm <sup>2</sup> , Box	4032248639953	42 pc(s).	Box



## System pitch 5.08 mm (0.200 inch) SL-SMT 5.08/06/90G 3.2SN BK BX

**Weidmüller Interface GmbH & Co. KG**  
 Klingenbergstraße 16  
 D-32758 Detmold  
 Germany  
 Fon: +49 5231 14-0  
 Fax: +49 5231 14-2083  
 www.weidmueller.com

## Counterpart

### BLZF 5.08/90B



Female connectors for connecting conductors with tension clamp system. The female connectors include space for labelling and can be coded. Packed in cardboard box.

- 0.20 - 2.5 mm<sup>2</sup> (IEC) / 26 - 12 AWG (UL)
- 400 V (IEC) / 300 V (UL)
- 16.5 A (IEC) / 10 A (UL)

### General ordering data

Order No.	Part designation	Version	GTIN (EAN)	Qty.	Packaging
<a href="#">1671290000</a>	BLZF 5.08/06/90B SN OR BX	PCB plug-in connector, female plug, 5.08 mm, No. of poles: 6, 90°, Tension clamp connection, Clamping range, max.: 3.31 mm <sup>2</sup> , Box	4008190432997	54 pc(s).	Box
<a href="#">1671520000</a>	BLZF 5.08/06/90B SN BK BX	PCB plug-in connector, female plug, 5.08 mm, No. of poles: 6, 90°, Tension clamp connection, Clamping range, max.: 3.31 mm <sup>2</sup> , Box	4008190433222	54 pc(s).	Box

### BLF 5.00/90LR SN



Just as reliable as the tried-and-true original, with innovation in detail:

The BLF 5.0x – the PUSH-IN version of the BLZ 5.0x socket block – features a new connection system and a more compact design. Weidmüller's innovative PUSH-IN spring connection features a trend-setting, tool-free wire connection system that is simple to operate.

In terms of versatility, the BLF 5.0x offers just as much as the older versions:

- The choice of three wire outlet directions offers you proven design flexibility for your applications.
- Four flange variations, including the patented release latch, allow for user-friendly unplugging designs.

### General ordering data

Order No.	Part designation	Version	GTIN (EAN)	Qty.	Packaging
<a href="#">1980910000</a>	BLF 5.00/06/90LR SN OR BX	PCB plug-in connector, female plug, 5.00 mm, No. of poles: 6, 90°, PUSH IN, Clamping range, max.: 3.31 mm <sup>2</sup> , Box	4032248676026	42 pc(s).	Box
<a href="#">1979830000</a>	BLF 5.00/06/90LR SN BK BX	PCB plug-in connector, female plug, 5.00 mm, No. of poles: 6, 90°, PUSH IN, Clamping range, max.: 3.31 mm <sup>2</sup> , Box	4032248674091	42 pc(s).	Box

## System pitch 5.08 mm (0.200 inch) SL-SMT 5.08/06/90G 3.2SN BK BX

**Weidmüller Interface GmbH & Co. KG**  
 Klingenbergstraße 16  
 D-32758 Detmold  
 Germany  
 Fon: +49 5231 14-0  
 Fax: +49 5231 14-2083  
 www.weidmueller.com

## Counterpart

### BLF 5.00/90F SN



Just as reliable as the tried-and-true original, with innovation in detail:

The BLF 5.0x – the PUSH-IN version of the BLZ 5.0x socket block – features a new connection system and a more compact design. Weidmüller's innovative PUSH-IN spring connection features a trend-setting, tool-free wire connection system that is simple to operate.

In terms of versatility, the BLF 5.0x offers just as much as the older versions:

- The choice of three wire outlet directions offers you proven design flexibility for your applications.
- Four flange variations, including the patented release latch, allow for user-friendly unplugging designs.

### General ordering data

Order No.	Part designation	Version	GTIN (EAN)	Qty.	Packaging
<a href="#">1979500000</a>	BLF 5.00/06/90F SN BK BX	PCB plug-in connector, female plug, 5.00 mm, No. of poles: 6, 90°, PUSH IN, Clamping range, max.: 3.31 mm², Box	4032248674701	42 pc(s).	Box
<a href="#">1980680000</a>	BLF 5.00/06/90F SN OR BX	PCB plug-in connector, female plug, 5.00 mm, No. of poles: 6, 90°, PUSH IN, Clamping range, max.: 3.31 mm², Box	4032248675838	42 pc(s).	Box

### BLT 5.08LH



Female connectors with TOP screw system for connecting conductors with straight 180° outlet direction. The female connectors include space for labelling and can be coded. Packed in cardboard box.

- 0.20 - 2.5 mm² (IEC) / 26 - 14 AWG (UL)
- 400 V (IEC) / 300 V (UL)
- 17 A (IEC) / 10 A (UL)

### General ordering data

Order No.	Part designation	Version	GTIN (EAN)	Qty.	Packaging
<a href="#">1892530000</a>	BLT 5.08/06/180LH SN BK BX	PCB plug-in connector, female plug, 5.08 mm, No. of poles: 6, 180°, TOP connection, Clamping range, max.: 2.5 mm², Box	4032248506576	42 pc(s).	Box
<a href="#">1890030000</a>	BLT 5.08/06/180LH SN OR BX	PCB plug-in connector, female plug, 5.08 mm, No. of poles: 6, 180°, TOP connection, Clamping range, max.: 2.5 mm², Box	4032248498444	42 pc(s).	Box

## System pitch 5.08 mm (0.200 inch) SL-SMT 5.08/06/90G 3.2SN BK BX

**Weidmüller Interface GmbH & Co. KG**  
 Klingenbergstraße 16  
 D-32758 Detmold  
 Germany  
 Fon: +49 5231 14-0  
 Fax: +49 5231 14-2083  
 www.weidmueller.com

## Counterpart

### BLZP 5.00/90F SN



Socket connectors with clamping yoke screw connection for conductor connection with a right-angle (90° or 270°) outlet direction. The female connectors provide space for labelling and can be coded. Can be fastened with flange or release latch. They feature an integrated plus/minus screw, protection against false insertion under clamping yoke. They are delivered with an opened clamping yoke.

- 0.2-2.5 mm<sup>2</sup> (IEC) / 26-12 AWG (UL)
- 400 V (IEC) / 300 V (UL)
- 15 A (IEC) / 10 A (UL)

#### General ordering data

Order No.	Part designation	Version	GTIN (EAN)	Qty.	Packaging
<a href="#">1959710000</a>	BLZP 5.00/06/90F SN BK BX	PCB plug-in connector, female plug, 5.00 mm, No. of poles: 6, 90°, Clamping yoke connection, Clamping range, max.: 4 mm <sup>2</sup> , Box	4032248638642	42 pc(s).	Box
<a href="#">1959480000</a>	BLZP 5.00/06/90F SN OR BX	PCB plug-in connector, female plug, 5.00 mm, No. of poles: 6, 90°, Clamping yoke connection, Clamping range, max.: 4 mm <sup>2</sup> , Box	4032248638413	42 pc(s).	Box

### BLZ 5.08/225B



Female connectors with clamping yoke screw connection for conductor connection with 225° outlet direction. The female connectors provide space for labelling and can be coded. Packed in cardboard box.

- 0.20 - 2.5 mm<sup>2</sup> (IEC) / 26 - 12 AWG (UL)
- 400 V (IEC) / 300 V (UL)
- 16.5 A (IEC) / 10 A (UL)

#### General ordering data

Order No.	Part designation	Version	GTIN (EAN)	Qty.	Packaging
<a href="#">1742370000</a>	BLZ 5.08/06/225B SN BK BX	PCB plug-in connector, female plug, 5.08 mm, No. of poles: 6, 225°, Clamping yoke connection, Clamping range, max.: 3.31 mm <sup>2</sup> , Box	4032248049806	54 pc(s).	Box
<a href="#">1742140000</a>	BLZ 5.08/06/225B SN OR BX	PCB plug-in connector, female plug, 5.08 mm, No. of poles: 6, 225°, Clamping yoke connection, Clamping range, max.: 3.31 mm <sup>2</sup> , Box	4008190247126	54 pc(s).	Box

## System pitch 5.08 mm (0.200 inch) SL-SMT 5.08/06/90G 3.2SN BK BX

**Weidmüller Interface GmbH & Co. KG**  
 Klingenbergstraße 16  
 D-32758 Detmold  
 Germany  
 Fon: +49 5231 14-0  
 Fax: +49 5231 14-2083  
 www.weidmueller.com

## Counterpart

### BLZ 5.08/270B



Female connectors with clamping yoke screw connection. The female connectors provide space for labelling and can be coded. Packed in cardboard box.

- 0.20 - 2.5 mm<sup>2</sup> (IEC) / 26 - 12 AWG (UL)
- 400 V (IEC) / 300 V (UL)
- 15 A (IEC) / 10 A (UL)

#### General ordering data

Order No.	Part designation	Version	GTIN (EAN)	Qty.	Packaging
<a href="#">1560010000</a>	BLZ 5.08/06/270B SN BK BX	PCB plug-in connector, female plug, 5.08 mm, No. of poles: 6, 270°, Clamping yoke connection, Clamping range, max.: 3.31 mm <sup>2</sup> , Box	4008190269692	54 pc(s).	Box
<a href="#">1560060000</a>	BLZ 5.08/06/270B SN OR BX	PCB plug-in connector, female plug, 5.08 mm, No. of poles: 6, 270°, Clamping yoke connection, Clamping range, max.: 3.31 mm <sup>2</sup> , Box	4008190069650	54 pc(s).	Box

### BLZP 5.00/180LH SN



Female connectors with clamping yoke screw connection for conductor connection with straight (180°) outlet direction. The female connectors provide space for labelling and can be coded. Can be fastened with flange or release latch. They feature an integrated plus/minus screw, protection against false insertion under clamping yoke. They are delivered with an opened clamping yoke.

- 0.2-2.5 mm<sup>2</sup> (IEC) / 26-12 AWG (UL)
- 400 V (IEC) / 300 V (UL)
- 19 A (IEC) / 15 A (UL)

#### General ordering data

Order No.	Part designation	Version	GTIN (EAN)	Qty.	Packaging
<a href="#">1956950000</a>	BLZP 5.00/06/180LH SN OR BX	PCB plug-in connector, female plug, 5.00 mm, No. of poles: 6, 180°, Clamping yoke connection, Clamping range, max.: 4 mm <sup>2</sup> , Box	4032248635832	45 pc(s).	Box
<a href="#">1957250000</a>	BLZP 5.00/06/180LH SN BK BX	PCB plug-in connector, female plug, 5.00 mm, No. of poles: 6, 180°, Clamping yoke connection, Clamping range, max.: 4 mm <sup>2</sup> , Box	4032248636068	45 pc(s).	Box

## System pitch 5.08 mm (0.200 inch) SL-SMT 5.08/06/90G 3.2SN BK BX

**Weidmüller Interface GmbH & Co. KG**  
Klingenbergstraße 16  
D-32758 Detmold  
Germany  
Fon: +49 5231 14-0  
Fax: +49 5231 14-2083  
www.weidmueller.com

## Counterpart

### BLZP 5.08/270LH SN



Socket connectors with clamping yoke screw connection for conductor connection with a right-angle (90° or 270°) outlet direction. The female connectors provide space for labelling and can be coded. Can be fastened with flange or release latch. They feature an integrated plus/minus screw, protection against false insertion under clamping yoke. They are delivered with an opened clamping yoke.

- 0.2-2.5 mm<sup>2</sup> (IEC) / 26-12 AWG (UL)
- 400 V (IEC) / 300 V (UL)
- 15 A (IEC) / 10 A (UL)

#### General ordering data

Order No.	Part designation	Version	GTIN (EAN)	Qty.	Packaging
<a href="#">1947050000</a>	BLZP 5.08/06/270LH SN OR BX	PCB plug-in connector, female plug, 5.08 mm, No. of poles: 6, 270°, Clamping yoke connection, Clamping range, max.: 4 mm <sup>2</sup> , Box	4032248622917	42 pc(s).	Box
<a href="#">1947280000</a>	BLZP 5.08/06/270LH SN BK BX	PCB plug-in connector, female plug, 5.08 mm, No. of poles: 6, 270°, Clamping yoke connection, Clamping range, max.: 4 mm <sup>2</sup> , Box	4032248623242	42 pc(s).	Box

### BLZF 5.08/270B



Female connectors for connecting conductors with tension clamp system. The female connectors include space for labelling and can be coded. Packed in cardboard box.

- 0.20 - 2.5 mm<sup>2</sup> (IEC) / 26 - 12 AWG (UL)
- 400 V (IEC) / 300 V (UL)
- 16.5 A (IEC) / 10 A (UL)

#### General ordering data

Order No.	Part designation	Version	GTIN (EAN)	Qty.	Packaging
<a href="#">1672670000</a>	BLZF 5.08/06/270B SN BK BX	PCB plug-in connector, female plug, 5.08 mm, No. of poles: 6, 270°, Tension clamp connection, Clamping range, max.: 3.31 mm <sup>2</sup> , Box	4008190434380	54 pc(s).	Box
<a href="#">1672440000</a>	BLZF 5.08/06/270B SN OR BX	PCB plug-in connector, female plug, 5.08 mm, No. of poles: 6, 270°, Tension clamp connection, Clamping range, max.: 3.31 mm <sup>2</sup> , Box	4008190434151	54 pc(s).	Box

## System pitch 5.08 mm (0.200 inch) SL-SMT 5.08/06/90G 3.2SN BK BX

**Weidmüller Interface GmbH & Co. KG**  
 Klingenbergstraße 16  
 D-32758 Detmold  
 Germany  
 Fon: +49 5231 14-0  
 Fax: +49 5231 14-2083  
 www.weidmueller.com

## Counterpart

### BLZP 5.08/225B SN



Clamping-yoke wire connection with right-angled (90° or 270°) or angled (225°) outlet direction. The female connectors provide space for labelling and can be coded. Can be fastened with flange or release latch. They feature an integrated plus/minus screw, protection against false insertion under clamping yoke. They are delivered with an opened clamping yoke.

- 0.2-2.5 mm<sup>2</sup> (IEC) / 26-12 AWG (UL)
- 400 V (IEC) / 300 V (UL)
- 17.5 A (IEC) / 10 A (UL)

#### General ordering data

Order No.	Part designation	Version	GTIN (EAN)	Qty.	Packaging
<a href="#">1946020000</a>	BLZP 5.08/06/225B SN BK BX	PCB plug-in connector, female plug, 5.08 mm, No. of poles: 6, 225°, Clamping yoke connection, Clamping range, max.: 4 mm <sup>2</sup> , Box	4032248621552	54 pc(s).	Box
<a href="#">1945790000</a>	BLZP 5.08/06/225B SN OR BX	PCB plug-in connector, female plug, 5.08 mm, No. of poles: 6, 225°, Clamping yoke connection, Clamping range, max.: 4 mm <sup>2</sup> , Box	4032248621262	54 pc(s).	Box

### BLZP 5.08/180LR SN



Female connectors with clamping yoke screw connection for conductor connection with straight (180°) outlet direction. The female connectors provide space for labelling and can be coded. Can be fastened with flange or release latch. They feature an integrated plus/minus screw, protection against false insertion under clamping yoke. They are delivered with an opened clamping yoke.

- 0.2-2.5 mm<sup>2</sup> (IEC) / 26-12 AWG (UL)
- 400 V (IEC) / 300 V (UL)
- 19 A (IEC) / 15 A (UL)

#### General ordering data

Order No.	Part designation	Version	GTIN (EAN)	Qty.	Packaging
<a href="#">1945100000</a>	BLZP 5.08/06/180LR SN BK BX	PCB plug-in connector, female plug, 5.08 mm, No. of poles: 6, 180°, Clamping yoke connection, Clamping range, max.: 4 mm <sup>2</sup> , Box	4032248620241	45 pc(s).	Box
<a href="#">1944870000</a>	BLZP 5.08/06/180LR SN OR BX	PCB plug-in connector, female plug, 5.08 mm, No. of poles: 6, 180°, Clamping yoke connection, Clamping range, max.: 4 mm <sup>2</sup> , Box	4032248619481	45 pc(s).	Box

## System pitch 5.08 mm (0.200 inch) SL-SMT 5.08/06/90G 3.2SN BK BX

**Weidmüller Interface GmbH & Co. KG**  
 Klingenbergstraße 16  
 D-32758 Detmold  
 Germany  
 Fon: +49 5231 14-0  
 Fax: +49 5231 14-2083  
 www.weidmueller.com

## Counterpart

### BLF 5.08/90F SN



Just as reliable as the tried-and-true original, with innovation in detail:

The BLF 5.0x – the PUSH-IN version of the BLZ 5.0x socket block – features a new connection system and a more compact design. Weidmüller's innovative PUSH-IN spring connection features a trend-setting, tool-free wire connection system that is simple to operate.

In terms of versatility, the BLF 5.0x offers just as much as the older versions:

- The choice of three wire outlet directions offers you proven design flexibility for your applications.
- Four flange variations, including the patented release latch, allow for user-friendly unplugging designs.

### General ordering data

Order No.	Part designation	Version	GTIN (EAN)	Qty.	Packaging
<a href="#">1000260001</a>	BLF 5.08/06/90F SN BK BX	PCB plug-in connector, female plug, 5.08 mm, No. of poles: 6, 90°, PUSH IN, Clamping range, max.: 3.31 mm², Box	4032248690220	42 pc(s).	Box
<a href="#">1002130000</a>	BLF 5.08/06/90F SN OR BX	PCB plug-in connector, female plug, 5.08 mm, No. of poles: 6, 90°, PUSH IN, Clamping range, max.: 3.31 mm², Box	4032248694082	42 pc(s).	Box

### BLZF 5.08/180LR



Female connectors for connecting conductors with tension clamp system, straight 180° outlet direction. The female connectors include space for labelling and can be coded. Packed in cardboard box.

- 0.20 - 2.5 mm² (IEC) / 26 - 12 AWG (UL)
- 400 V (IEC) / 300 V (UL)
- 17 A (IEC) / 15 A (UL)

### General ordering data

Order No.	Part designation	Version	GTIN (EAN)	Qty.	Packaging
<a href="#">1892760000</a>	BLZF 5.08/06/180LR SN BK BX	PCB plug-in connector, female plug, 5.08 mm, No. of poles: 6, 180°, Tension clamp connection, Clamping range, max.: 3.31 mm², Box	4032248506804	42 pc(s).	Box
<a href="#">1851450000</a>	BLZF 5.08/06/180LR SN OR BX	PCB plug-in connector, female plug, 5.08 mm, No. of poles: 6, 180°, Tension clamp connection, Clamping range, max.: 3.31 mm², Box	4032248382927	42 pc(s).	Box