





Grayhill, Inc.

## 62S11-M0-PH

Numéro d'article:	62S11-M0-PH
Fabricant / marque:	Grayhill, Inc.
Description du produit	ROTARY ENCODER OPTICAL 32PPR
Feuilles de données:	 62S11-M0-PH.pdf
Statut RoHS	 Sans plomb / conforme à la directive RoHS
Bateau de	Hong Kong
Manière d'expédition	DHL/Fedex/TNT/UPS/EMS

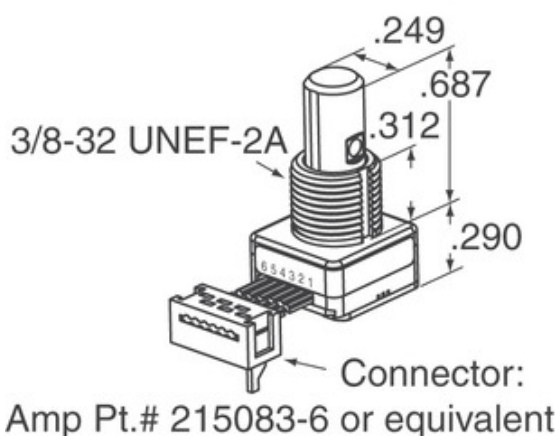
[DEMANDE DE DEVIS](#)

L'image peut être une représentation. Voir les spécifications pour les détails du produit.







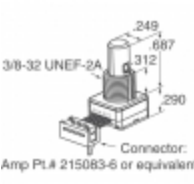

### Spécifications de 62S11-M0-PH

NUMÉRO D'ARTICLE	62S11-M0-PH
FABRICANT	Grayhill, Inc.
LA DESCRIPTION	ROTARY ENCODER OPTICAL 32PPR
ÉTAT SANS PLOMB / ÉTAT ROHS	Sans plomb / conforme à la directive RoHS
FICHE TECHNIQUE	 62S11-M0-PH.pdf
TENSION - ALIMENTATION	5V
STYLE DE RACCORDEMENT	PC Pin
SÉRIES	62S
VIE ROTATIONAL (CYCLES MIN)	1M
IMPULSIONS PAR TOUR	32
LE TYPE DE SORTIE	Quadrature (Incremental)
AUTRES NOMS	62S11M0PH
ORIENTATION	Vertical
TYPE DE MONTAGE	PCB, Through Hole
NIVEAU DE SENSIBILITÉ À L'HUMIDITÉ (MSL)	1 (Unlimited)
DÉLAI DE LIVRAISON STANDARD DU FABRICANT	8 Weeks
STATUT SANS PLOMB / STATUT ROHS	Lead free / RoHS Compliant
TYPE DE CODEUR	Optical
DETENT	Yes
COMMUTATEUR INTÉGRÉ	No
TYPE D'ACTIONNEUR	1/4" Dia Flatted End

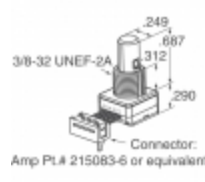
### Tags associés

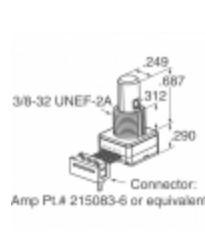
Grayhill, Inc. 62S11-M0-PH	Distributeur 62S11-M0-PH	Fournisseur 62S11-M0-PH
Prix 62S11-M0-PH	Photos de 62S11-M0-PH	62S11-M0-PH Image
Fiche technique PDF 62S11-M0-PH	62S11-M0-PH Télécharger la fiche technique	Fiche technique 62S11-M0-PH
Stock 62S11-M0-PH	Acheter 62S11-M0-PH	Acheter Grayhill, Inc. 62S11-M0-PH
Grayhill, Inc. 62S11-M0-PH	Fournisseur Grayhill, Inc.	Distributeur Grayhill, Inc.
Grayhill, Inc. 62S11-M0-PH	Grayhill Inc. 62S11-M0-PH	

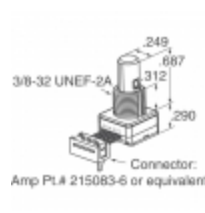
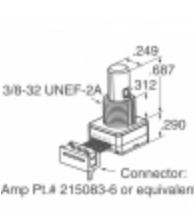
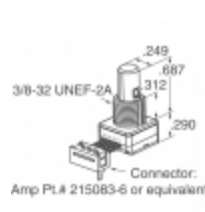
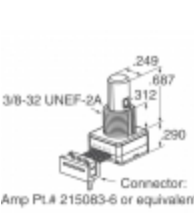
### Produits connexes

 <p><b>62S11-M5-030C</b> Fabricants: Grayhill, Inc. La description: ROTARY ENCODER OPTICAL 32PPR En stock: Out stock</p> <p><a href="#">RFQ</a></p>	 <p><b>62S11-M0-050C</b> Fabricants: Grayhill, Inc. La description: ROTARY ENCODER OPT 32PPR 5" CBL En stock: 9 pcs</p> <p><a href="#">RFQ</a></p>
 <p><b>62S11-M5-020C</b> Fabricants: Grayhill, Inc. La description: ROTARY ENCODER OPT 32PPR 2" CBL En stock: Out stock</p> <p><a href="#">RFQ</a></p>	 <p><b>62S11-M0-060CH</b> Fabricants: Grayhill, Inc. La description: ROTARY ENCODER OPTICAL 32PPR En stock: Out stock</p> <p><a href="#">RFQ</a></p>
 <p><b>62S11-M0-060C</b> Fabricants: Grayhill, Inc. La description: ROTARY ENCODER OPT 32PPR 6" CBL En stock: Out stock</p> <p><a href="#">RFQ</a></p>	 <p><b>62S11-M5-020S</b> Fabricants: Grayhill, Inc. La description: ROTARY ENCODER OPTICAL 32PPR En stock: Out stock</p> <p><a href="#">RFQ</a></p>
 <p><b>62S11-M0-P</b> Fabricants: Grayhill, Inc. La description: ROTARY ENCODER OPTICAL 32PPR En stock: Out stock</p> <p><a href="#">RFQ</a></p>	 <p><b>62S11-M0-200S</b> Fabricants: Grayhill, Inc. La description: ROTARY ENCODER OPTICAL 32PPR En stock: Out stock</p> <p><a href="#">RFQ</a></p>
 <p><b>62S11-M5-020CH</b> Fabricants: Grayhill, Inc. La description: ROTARY ENCODER OPTICAL 32PPR En stock: Out stock</p> <p><a href="#">RFQ</a></p>	 <p><b>62S11-M0-PV</b> Fabricants: Grayhill, Inc. La description: ROTARY ENCODER OPTICAL 32PPR En stock: Out stock</p> <p><a href="#">RFQ</a></p>
 <p><b>62S11-M5-020SH</b> Fabricants: Grayhill, Inc. La description: ROTARY ENCODER OPT 32PPR 2" CBL En stock: Out stock</p> <p><a href="#">RFQ</a></p>	 <p><b>62S11-M0-210SH</b> Fabricants: Grayhill, Inc. La description: ROTARY ENCODER OPT 32PPR 20" CBL En stock: Out stock</p> <p><a href="#">RFQ</a></p>