





Grayhill, Inc.

62S11-M9-020C

Numéro d'article:	62S11-M9-020C
Fabricant / marque:	Grayhill, Inc.
Description du produit	ROTARY ENCODER OPTICAL 32PPR
Feuilles de données:	 62S11-M9-020C.pdf
Statut RoHS	 Sans plomb / conforme à la directive RoHS
Bateau de	Hong Kong
Manière d'expédition	DHL/Fedex/TNT/UPS/EMS

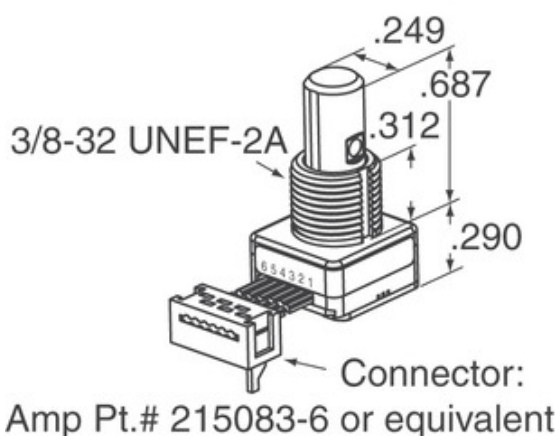
[DEMANDE DE DEVIS](#)

L'image peut être une représentation. Voir les spécifications pour les détails du produit.







Spécifications de 62S11-M9-020C

NUMÉRO D'ARTICLE	62S11-M9-020C
FABRICANT	Grayhill, Inc.
LA DESCRIPTION	ROTARY ENCODER OPTICAL 32PPR
ÉTAT SANS PLOMB / ÉTAT ROHS	Sans plomb / conforme à la directive RoHS
FICHE TECHNIQUE	 62S11-M9-020C.pdf
TENSION - ALIMENTATION	5V
STYLE DE RACCORDEMENT	Cable with Connector
SÉRIES	62S
VIE ROTATIONAL (CYCLES MIN)	1M
IMPULSIONS PAR TOUR	32
LE TYPE DE SORTIE	Quadrature (Incremental)
AUTRES NOMS	62S11M9020C
ORIENTATION	Vertical
TYPE DE MONTAGE	Panel Mount
NIVEAU DE SENSIBILITÉ À L'HUMIDITÉ (MSL)	1 (Unlimited)
DÉLAI DE LIVRAISON STANDARD DU FABRICANT	8 Weeks
STATUT SANS PLOMB / STATUT ROHS	Lead free / RoHS Compliant
TYPE DE CODEUR	Optical
DETENT	Yes
COMMUTATEUR INTÉGRÉ	Yes
TYPE D'ACTIONNEUR	1/4" Dia Flatted End

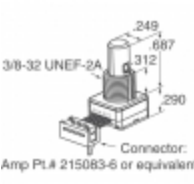
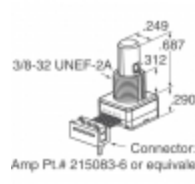
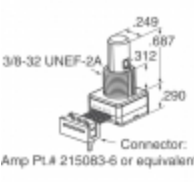
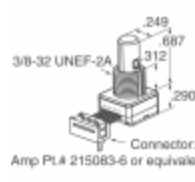
Tags associés

Grayhill, Inc. 62S11-M9-020C	Distributeur 62S11-M9-020C	Fournisseur 62S11-M9-020C
Prix 62S11-M9-020C	Photos de 62S11-M9-020C	62S11-M9-020C Image
Fiche technique PDF 62S11-M9-020C	62S11-M9-020C Télécharger la fiche technique	Fiche technique 62S11-M9-020C
Stock 62S11-M9-020C	Acheter 62S11-M9-020C	Acheter Grayhill, Inc. 62S11-M9-020C
Grayhill, Inc. 62S11-M9-020C	Fournisseur Grayhill, Inc.	Distributeur Grayhill, Inc.
Grayhill, Inc. 62S11-M9-020C	Grayhill Inc. 62S11-M9-020C	

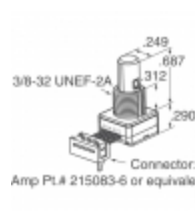
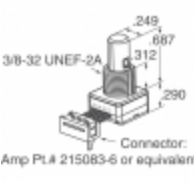
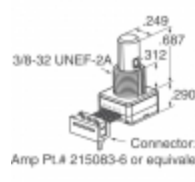
Produits connexes

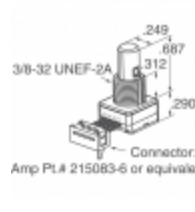
 <p>62S11-M5-135S Fabricants: Grayhill, Inc. La description: ROTARY ENCODER OPTICAL 32PPR En stock: Out stock</p> <p>RFQ</p>	 <p>62S11-M9-030S Fabricants: Grayhill, Inc. La description: ROTARY ENCODER OPTICAL 32PPR En stock: Out stock</p> <p>RFQ</p>
 <p>62S11-M9-020S Fabricants: Grayhill, Inc. La description: ROTARY ENCODER OPTICAL 32PPR En stock: Out stock</p> <p>RFQ</p>	 <p>62S11-M9-025S Fabricants: Grayhill, Inc. La description: ROTARY ENCODER OPTICAL 32PPR En stock: Out stock</p> <p>RFQ</p>
 <p>62S11-M9-020CH Fabricants: Grayhill, Inc. La description: ROTARY ENCODER OPTICAL 32PPR En stock: Out stock</p> <p>RFQ</p>	 <p>62S11-M5-120C Fabricants: Grayhill, Inc. La description: ROTARY ENCODER OPTICAL 32PPR En stock: Out stock</p> <p>RFQ</p>
 <p>62S11-M5-P Fabricants: Grayhill, Inc. La description: ROTARY ENCODER OPTICAL 32PPR En stock: 97 pcs</p> <p>RFQ</p>	 <p>62S11-M5-120CH Fabricants: Grayhill, Inc. La description: ROTARY ENCODER OPTICAL 32PPR En stock: Out stock</p> <p>RFQ</p>
 <p>62S11-M9-040C Fabricants: Grayhill, Inc. La description: ROTARY ENCODER OPTICAL 32PPR En stock: Out stock</p> <p>RFQ</p>	 <p>62S11-M5-120SH Fabricants: Grayhill, Inc. La description: ROTARY ENCODER OPTICAL 32PPR En stock: Out stock</p> <p>RFQ</p>
 <p>62S11-M5-PH Fabricants: Grayhill, Inc. La description: ROTARY ENCODER OPTICAL 32PPR En stock: 59 pcs</p> <p>RFQ</p>	 <p>62S11-M9-040SH Fabricants: Grayhill, Inc. La description: ROTARY ENCODER OPT 32PPR 4" CBL En stock: Out stock</p> <p>RFQ</p>