

MPQ Manufacturing Programmer User's Guide

November, 2010

- **Cypress PSoC**
- **Zilog Z8-Encore!, ZLF645**
- **Cypress enCoRe II**
- **Silicon Labs C8051F3xx**
- **Zilog ZNEO**
- **Atmel AVR**
- **Atmel AVR32**

RPM Systems Corporation
Redmond, Washington, USA
(425)869-3901 www.rpmsys.com

Contents

1. MPQ Overview	5
1.1 MPQ Connections	5
1.2 Programming Images	5
2. MPQ Setup and Operation	7
2.1 Installing the MP Manager Software	7
2.2 Connecting MPQ Power and Communications	7
2.2.1 Using a USB to Serial Communications Adapter with MPQ	7
2.3 Starting MP Manager Software and Connecting to MPQ	7
2.4 Loading Image Files into MPQ Flash	9
2.4.1 Selecting Programming Parameters	9
2.4.2 Security Settings	11
2.4.3 Serialization	11
2.5 Deleting Images from Programmer Flash	13
2.6 Programming Devices from MP Manager	13
2.6.1 Enabling and Disabling Target Ports	15
2.6.2 Verifying Devices	15
2.6.3 Programming Errors	15
2.6.4 CRC or Checksum Verify	15
2.6.5 Programming Options	16
2.7 Reading Images from Target Devices	16
2.8 Uploading Images from MPQ	17
2.9 Array Programming from MP Manager	17
3.0 Stand-alone Device Programming	19
3.1 Default Image and Port Enable Selections	19
4.0 Interfacing MPQ with Automated Test Equipment	21
4.1 Control Connector Signal Description	21
4.1.1 Active# Control	21
4.1.2 ATE Pass/Fail Status	22
4.1.3 ATE Option Selection	23
4.1.4 ATE Option Setup	23

5.0 MPQ Arrays	25
5.1 Stand-Alone Arrays	25
5.2 ATE Controlled Arrays	25
5.3 PC-Controlled Arrays	25
Appendix A - Cypress PSoC Microcontrollers	27
A.1 Device Options	27
A.1.1 Device Type	27
A.1.2 Target Voltage	27
A.1.3 Mode	28
A.2 Programming Options	28
A.3 PSoC Target Cable Connections	28
Appendix B - Zilog Z8 Encore! and ZLF645	30
B.1 Device Options	30
B.1.1 Device Type	30
B.1.2 Target Voltage	30
B.1.3 Mode	31
B.1.4 Target Frequency	31
B.1.5 Special Considerations for 8-pin and Crimson Parts	31
B.2 Programming Options	31
B.3 - Target Cable Connections	32
Appendix C - Cypress enCoRe II Microcontrollers	34
C.1 Device Options	34
C.1.1 Device Type	34
C.1.2 Target Voltage	35
C.2 Programming Options	35
C.3 enCoRe II Target Cable Connections	35
C.4 Powered USB Interface Option	36
Appendix D - Silicon Labs C8051F3xx Microcontrollers	38
D.1 Device Options	38
D.1.1 Device Type	38
D.1.2 Target Voltage	39
D.1.3 Mode	39
D.2 Programming Options	39
D.3 Silicon Labs C8051F3xx Target Cable Connections	39

Appendix E - Zilog ZNEO	41
E.1 Device Options	41
E.1.1 Device Type	41
E.1.2 Target Voltage	42
E.1.3 Mode	42
E.2 Programming Options	42
E.3 - Target Cable Connections	43
Appendix F - Atmel AVR	45
F.1 Device Options	45
F.1.1 Device Type	45
F.1.2 Target Voltage	45
F.1.3 Mode	46
F.1.4 Target Frequency	46
F.1.5 SPI/JTAG Protocol Select	46
F.2 Programming Options	46
F.2.1 Fuse Values	46
F.2.2 EEPROM Programming	47
F.2.3 OSCCAL Programming	48
F.3 - Target Cable Connections	48
Appendix G - Atmel AVR32	51
G.1 Device Options	51
G.1.1 Device Type	51
G.1.2 Target Voltage	51
G.1.3 Mode	52
G.2 Programming Options	52
G.2.1 Fuse Values	52

1. MPQ Overview

The MPQ Manufacturing Programmer is a four port device programmer for In System Programming (ISP) of microcontrollers. MPQ allows you to:

- program up to four devices simultaneously from one MPQ
- build arrays of up to 16 MPQ programmers to program up to 64 devices simultaneously
- store up to four different device images in programmer Flash
- use stand-alone (push-button), PC-controlled or ATE (Automated Test Equipment)-controlled modes of operation
- accommodate target device voltages from 1.8 to 5.5V

1.1 MPQ Connections

The MPQ has three external connectors: the Power connector, the Control connector and the Target connector. The Control connector is a 25-pin Female D Subminiature connector through which external control of MPQ operations takes place. A Communications Cable is provided with the MPQ, which provides a connection between its Control port and a host PC serial port for communications with the MP Manager software.

The Target connector is a 30-pin 2mm male header which provides programming signals for up to four target devices. The Power connector is a 2.1mm male barrel connector, through which the MPQ itself is powered. A Target Cable assembly is provided with MPQ which connects its Target port to the circuit board(s) containing the ISP devices to be programmed. RPM offers several termination options for the target end of Target Cables depending upon the particular microcontroller being supported. Target connector options and pin assignments are outlined in the appendices of this manual.

MPQ senses the target system power supply voltage on each of the four ports to determine when target voltage is at acceptable levels for programming. The MPQ does not provide power to the target systems. The power drawn by the MPQ from each target system for target voltage sensing is less than 1mA.

A power supply is provided with the MPQ, which plugs directly into the MPQ's Power connector, and which is capable of operation from any 50/60Hz, 100 ~ 240VAC power source.

1.2 Programming Images

Images to be programmed into the target devices are stored in the MPQ's internal Flash memory. Up to four different images can be stored in the MPQ. Images are loaded into MPQ flash from a file on the host PC, or by reading a programmed device, using the MP Manager software provided with the MPQ. Additional information required to program the target device, such as device type, target voltage and programming mode, is provided by the operator at the time each image is loaded, and is stored with the image in the programmer. Once an image is loaded into flash and the programmer's Target Cable is connected to the target systems, programming can be initiated in one of three ways: by pushing the green button on the top of the MPQ box (stand-alone mode), by asserting the Active# line on the Control connector (ATE mode), or on command from

the MP Manager host software (PC-controlled mode).

While programming is in progress, the MPQ's Active LED will be lit. Upon completion of programming, the Active LED will be doused, and completion status for each of the four ports will be displayed on the Pass/Fail status LEDs. Disabled ports will not display LED pass/fail status.

2. MPQ Setup and Operation

Before any devices can be programmed, the MPQ must be configured and target images loaded into its internal Flash memory.

2.1 Installing the MP Manager Software

MP Manager software is provided on the CD-ROM included with the MPQ. It can also be downloaded from the RPM Systems web site at: <http://www.rpmsys.com/mpq.html>. Minimum system requirements for MP Manager operation are a 600MHz Pentium class computer with 64 MBytes of RAM, 40MBytes of available disk space and one available serial port. MP Manager is compatible with Microsoft Windows 98, Windows NT, Windows 2000 and Windows XP operating systems.

To install MP Manager, insert the CD-ROM in the CD drive of the computer. If the installer does not start automatically, browse to the *MP Manager* folder on the CD-ROM, and run the *setup.exe* file from that folder. Follow the on-screen instructions to complete installation of MP Manager on the computer. Once MP Manager has been installed, it can be invoked from the Windows Start menu.

2.2 Connecting MPQ Power and Communications

Connect the MPQ-PS power supply provided with your MPQ to the programmer, and plug it into a 90 to 240VAC, 50/60Hz power outlet. Then connect the Communications Cable, also provided, to the MPQ Control connector, and to a 9-pin serial port on the PC host.

2.2.1 Using a USB to Serial Communications Adapter with MPQ

Many newer computers do not provide an RS-232 serial communications port, instead providing a Universal Serial Bus (USB) standard port. Adapters are available which allow the USB port to be used to communicate with the MPQ's serial interface. If you wish to use a USB to serial adapter with your MPQ, please contact RPM Systems for recommended products, or to purchase an adapter from us directly.

2.3 Starting MP Manager Software and Connecting to MPQ

With MPQ powered on and connected the host PC as outlined in the previous section, start the MP Manager software on the host PC (Start/MP Manager/MP Manager). In the main MP Manager window, select the communications port to which the MPQ is attached, then click the Scan for Programmers tool button to locate and connect to programmers connected to that COM port.

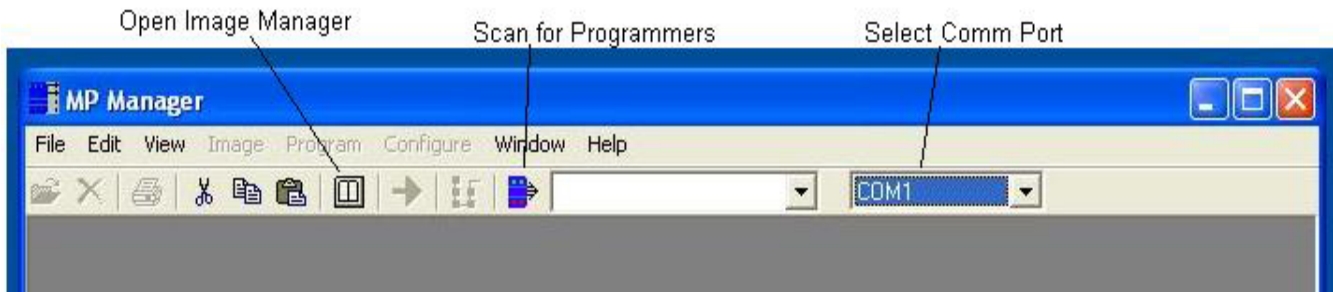

The software will display the status message "Acquiring Programmers", and a progress bar will be displayed, while it queries the serial port to identify the programmer(s) attached. A list of the programmers connected to the COM port will be displayed in the programmer select box. If a programmer is not detected, ensure that the programmer is powered on, that the communications cable is properly connected, and that the proper communications port is selected in the MP Manager main window.

The currently selected programmer will be shown in the programmer select box. Click on the Image Manager toolbar button to open the image manager. The *Programmer* frame on the left-hand side of the Image Manager window will show information regarding the currently selected programmer - model number, device support and revision information. The right side of the Image Manager window will show a list of the images currently programmed into the Flash memory of the programmer. For a new programmer, this list will be empty.

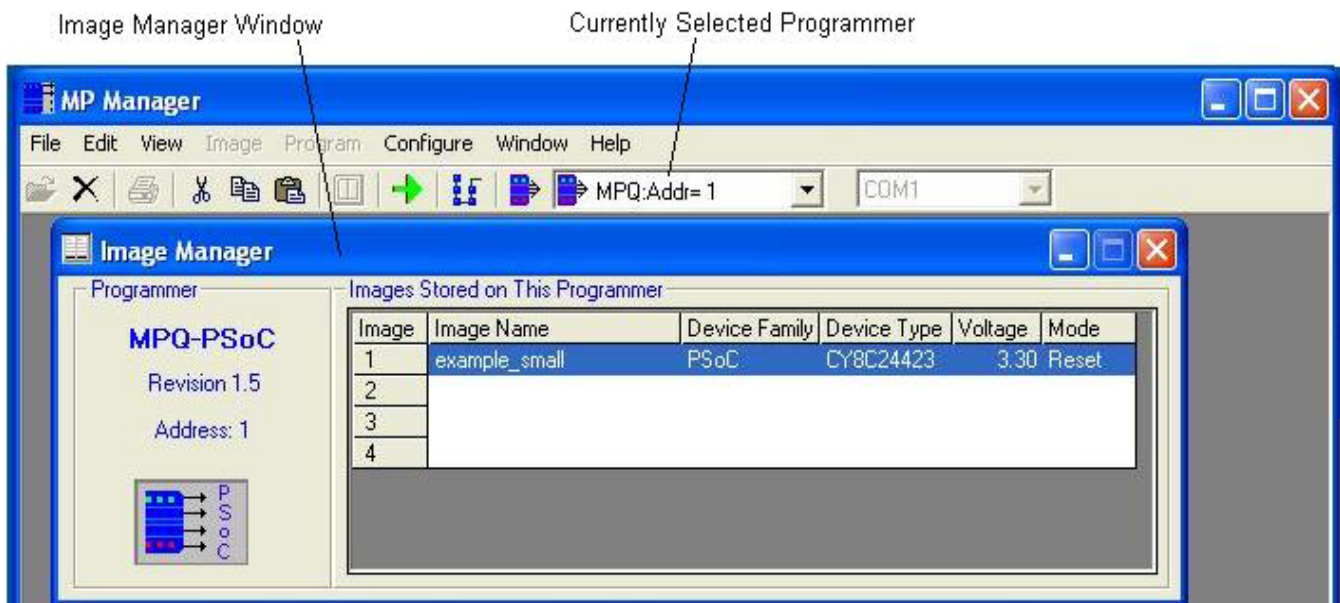

2.4 Loading Image Files into MPQ Flash

To load a new image file into programmer Flash, first select which of the four Image banks, Image 1, 2, 3 or 4, shown in the "Images Stored on This Programmer" frame, will receive the new image. Do this by clicking one of the Image numbers with your mouse, or using the arrow keys on your keyboard. Note that, if the bank you select already contains an image, that image will be overwritten with the new image.

Next, select the *Image/Load Image File* option from the MP Manager menu bar, or select the *File-Open* tool bar button. This will open a file browse box. Browse to find the image file you wish to load. The image file will be a .hex file which was created using the development software for the particular microcontroller supported by your MPQ. Once you have selected the image, MPQ reads the .hex file and verifies that it is valid. The "Load Image from File" dialog box will then appear. In this dialog box, you will name the image and select the programming parameters which will be stored with this image in programmer Flash. (Note: if you "Cancel" the file browse box without selecting an image, the Load Image from File dialog will open with an empty image file name).

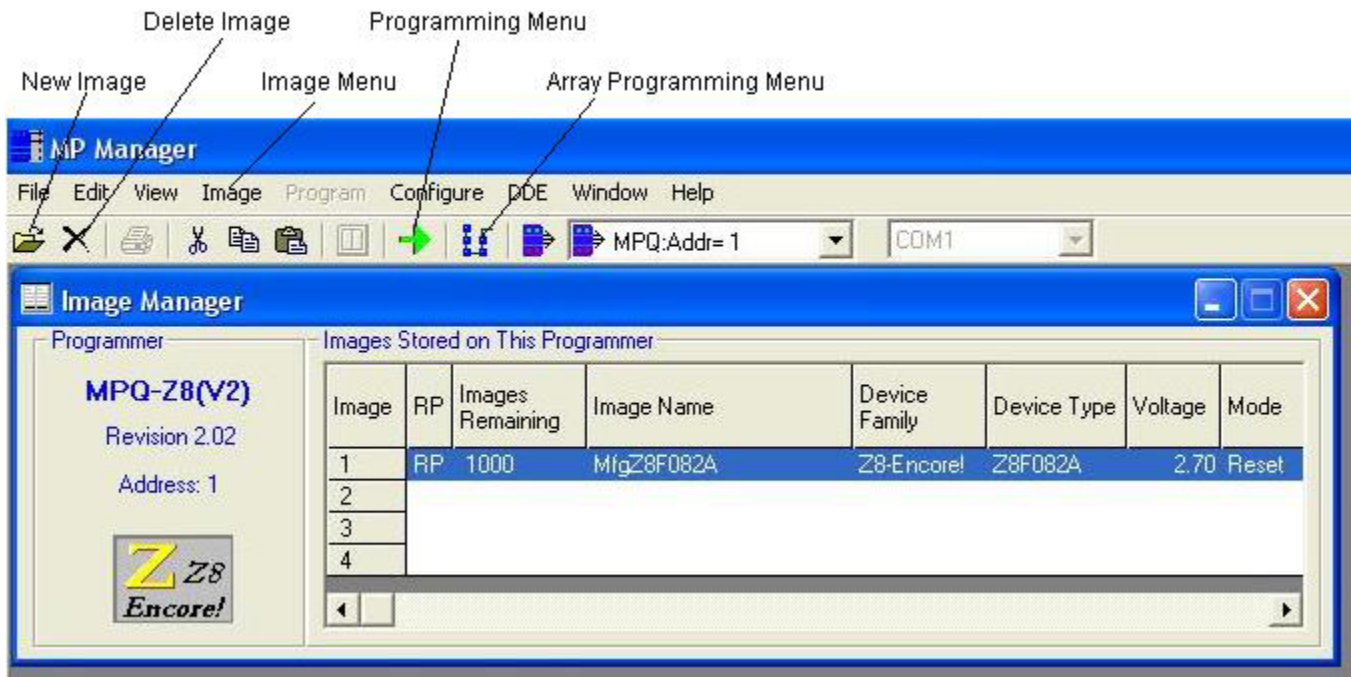

2.4.1 Selecting Programming Parameters

The Load Image dialog allows you to name the new image and to select other parameters necessary for the programmer to properly program devices.

MPQ Manufacturing Programmer User's Guide

The Image Name is purely for user convenience. It is stored with the image in Flash, and is intended to help you identify the image. The Image Name defaults to the name of the .hex image file, but could be changed, for instance, to indicate the part number and revision of the firmware.

Once the Load Image dialog is open, you may choose a different image file by clicking on the ellipses next to the Image File. This will reopen the file browse box.

The Image Number shown in the Load Image dialog is the number of the image bank selected in the Image Manager window. To choose a different image, switch to the Image Manager window, select the desired image, then switch back to the Programmer Manager.

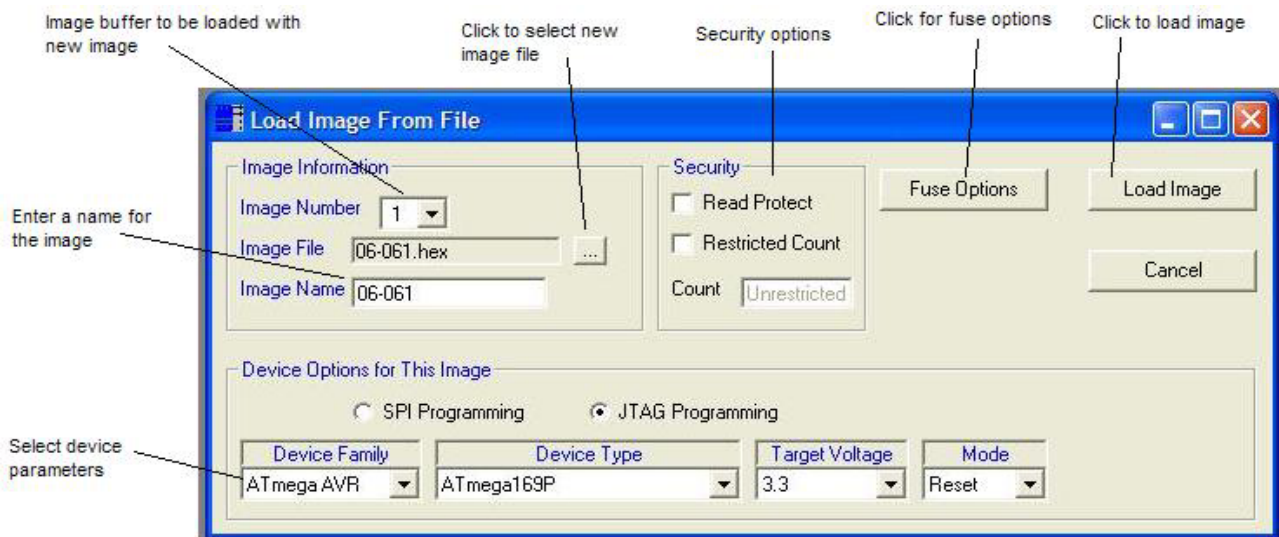

The drop-down boxes at the bottom of the Load Image dialog allow you to specify the device family (depends upon the microcontrollers supported by each MPQ), device type, target voltage and programming mode. The target voltage information is used by the programmer to determine when power on the target system is viable, as well as to determine at what voltage level to drive the programming signals to the target system.

The device parameters window will always display the Device Family, Device Type and Target Voltage parameters. Other parameters displayed in this window will depend upon the particular device type being programmed. Device Options information specific to each device family is provided in the appendices of this document.

Once you have selected the desired image file and programming parameters, click the Load Image button to load the new image into programmer Flash. MP Manager will display status messages and a progress bar indicating that it is downloading the image to the programmer, then verifying it, after which a message box will be displayed indicating that the download is complete.

Images in any of the four banks may also be replaced using this process.

MPQ Manufacturing Programmer User's Guide

2.4.2 Security Settings

The security settings provide some measure of protection against access to your image information by unauthorized individuals, as well as a programmable limit to the number of device which can be programmed from the image.

The Read Protect option prevents the ability to upload the image from the programmer and save it to a file (i.e., the Image/Save Image to File option is not available for this image). Selecting this option has no effect on the use of the image for programming devices, it simply cannot be read out of the programmer for storage on the host PC.

The Restricted Count option allows you to limit the total number of devices which can be programmed with this image. If this option is selected, the number of cycles indicated in the "Count" field will be the total number of devices which may be successfully programmed with the image. Once the count is exhausted, subsequent attempts to program with this image will fail, and a new copy of the image must be loaded from the host to authorize additional programming cycles. Note that, when the "Restricted Count" option is selected, the "Read Protect" option will automatically be selected as well.

NOTE: Only the Read Protect option is available on older MPQ (V1) programmers. Both Read Protect and Restricted Count functionality is available on V2 and later programmers.

The security settings for each image, as well as the number of cycles remaining for restricted-count images, are shown in the Image Manager.

Image is Read Protected 1000 program cycles remaining

Image	RP	Images Remaining	Image Name	Device Family	Device Type	Voltage	Mode
1	RP	1000	MfgZ8F082A	Z8-Encore!	Z8F082A	2.70	Reset
2	Unrestricted	Test Image 1	Z8-Encore!	Z8F082A	2.70	Reset	
3							
4							

Image is not Read Protected No restriction on programming cycles

2.4.3 Serialization

Some MPQ programmers support serialization of the programmed devices. This feature allows the opera-

MPQ Manufacturing Programmer User's Guide

tor to define an address in target microcontroller memory which can contain a 2-byte, 4-byte or 6-byte binary serial number, which is automatically incremented by the programmer for each subsequent device programmed. The serialization dialog is invoked from the Load Image dialog. It allows the user to select a target address for the serial number, a memory space (Flash or EEPROM, depending upon the device family), the size of the serial number area in the target memory, in bytes, and the starting serial number value. The byte ordering of the serial number information written to the target is selectable, LSB first or MSB first.

After the image has been loaded, and after any number of programming cycles, the current serial number for each image can be viewed from the Image Manager window by selecting the image bank, then selecting *View Serialization* from the *Image* menu, or by right-clicking on the image in the Image Manager, and selecting *View Serialization* from the popup menu.

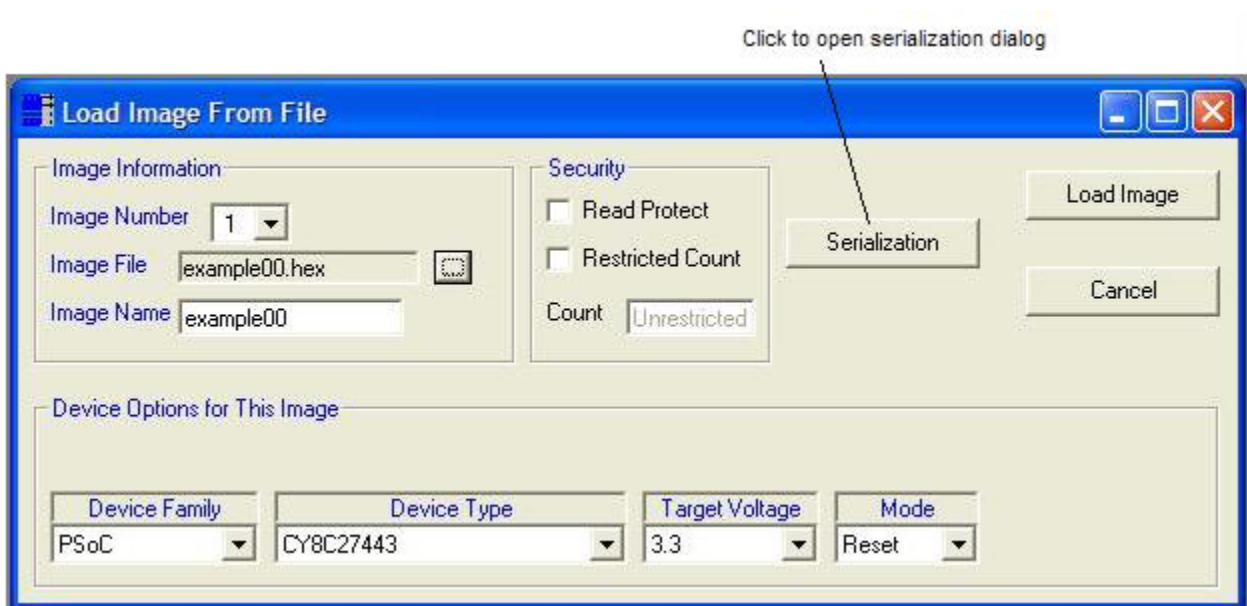

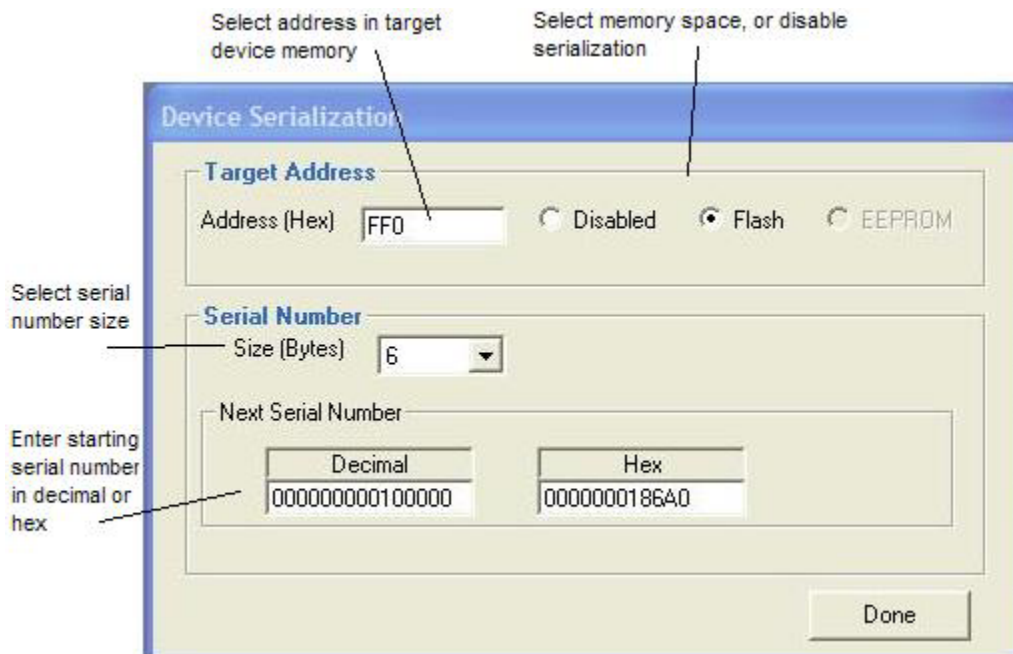

2.5 Deleting Images from Programmer Flash

It is not necessary to delete an image from the target Flash before replacing it with a new image. However, there are occasions when it may be desirable to remove an image from the programmer, for instance to ensure that it is no longer used to program devices. To delete images from the programmer, start the Image Manager window as previously described, and select the image to be deleted, either by clicking on the image number or using the keyboard arrow keys. Then select the *Image/Delete Image* option from the MP Manager menu bar, or the *Delete* button on the tool bar. You will be queried to be certain that you want to delete the image. If you chose to do so, the image will be deleted from the programmer.

2.6 Programming Devices from MP Manager

Once an image or images have been loaded into the programmer Flash, programming operations can be initiated directly from MP Manager if you so desire. First, ensure that the Target cable is connected between the MPQ's Target connector and the system or systems to be programmed (see appendices for a discussion of target system connections). In the Image Manager window, select the image to be programmed. Next, open the Programming Manager by selecting the *Programming Manager* tool bar button, or by selecting the *View/Programming Manager* option from the MP Manager menu bar. This will cause the Programming Manager window to be opened.

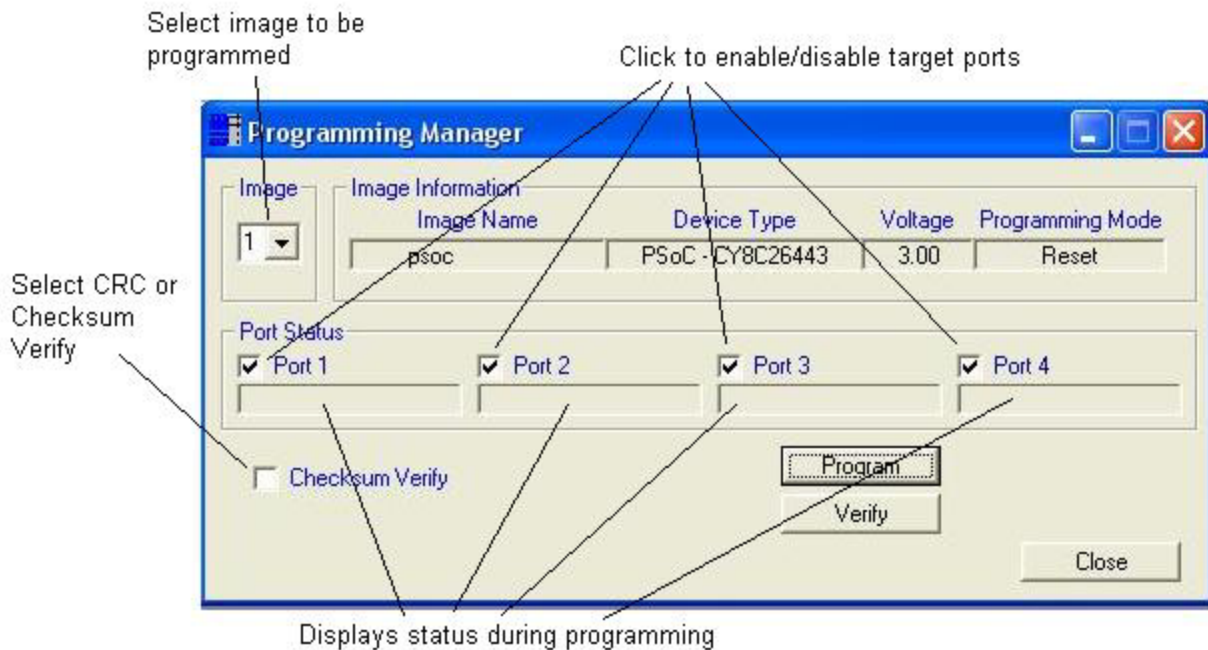

The Programming Manager shows the programming information for the image to be programmed. When the Programming Manager is opened, it defaults to the image which was selected in the Image Manager window. To choose a different image, use the drop-down box in the Image pane on the left side of the Programming Manager window.

To initiate programming, click the Program button, or select the *Program/Program* option from the MP Manager menu bar. During programming, status will be displayed for all four ports as each device is programmed and verified. If power is not applied to the target systems when programming is initiated, the MPQ will wait approximately 10 seconds for power to be applied. As soon as valid power is detected on all four ports, programming will begin. If power has not been detected on all enabled ports after 10 seconds, the MPQ will proceed to program all ports on which power is detected, and will display an error status for those enabled ports on which power was not detected.

While the programming operation is in progress, status will be displayed for all enabled ports in the Programmer Port Status frame. Upon completion of programming, this status will indicate Done if programming is successful, or a failure status if it is not. In addition, pass/fail status for each port will be displayed on the MPQ's status LEDs at the completion of programming.

Once the Programming Manager window is open, you may run multiple programming cycles simply by clicking the Program button to start each new cycle. If you would like to switch images, you can do so by switching to the Image Manager window, selecting a different image, then switching back to the Programming Manager window. It is not necessary to close and reopen the Programming Manager.

2.6.1 Enabling and Disabling Target Ports

Enable or disable target ports by checking or uncheck the boxes next to each target port in the Programmer Port Status frame. A check mark in the box indicates that the port is enabled. It is not necessary to disable ports that are not attached to a target system, however doing so does make the programming cycle go more quickly for the enabled ports, as the MPQ is not required to wait for the 10-second power time-out period to expire.

2.6.2 Verifying Devices

All devices are verified immediately after programming during the Program cycle, before the security fuses are programmed. However, a separate verify-only cycle may be performed by clicking the Verify button in the Programming Manager window, or by selecting the *Program/Verify* option from the MP Manager menu bar. Note that most microcontrollers contain security fuses which can be programmed to prevent subsequent reading of the device's program memory. If these fuses were programmed to setting other than "Unprotected" during the initial programming cycle, the device can not be read back, and **VERIFY WILL FAIL**.

2.6.3 Programming Errors

The following failure statuses may be reported in the Programmer Port Status frame:

No Target Vcc	No power was detected on the port within 10 seconds of program initiation
Device Timeout	The device stopped responding during the program/verify sequence
Verify Failed	Data read back from the device after programming was incorrect
Device ID Failed	The device ID read from the device being programmed did not match the target device type specified for the image
VCC Present	Target Vcc was already present when a Power-On programming cycle was initiated

2.6.4 CRC or Checksum Verify

When MPQ programs a device, it normally reads the entire device contents and compares it to the programming image in order to verify that the part was programmed correctly. The read-verify operation ensures that the programmed image is 100% correct, but lengthens the overall duration of the program cycle. Some microcontrollers, however, allow a CRC or checksum to be read from the device once it is programmed. MPQ can use this capability to reduce program cycle time by verifying that the device CRC or checksum matches the value expected for the programmed image. This allows a sometimes substantial time savings on each program cycle, with relatively little risk of not identifying improperly programmed devices. By checking the "CRC Verify" or "Checksum Verify" box in the Program Manager window, the operator can elect to have MPQ verify programming by this method, rather than performing a complete read-verify.

2.6.5 Programming Options

Some devices offer programming options, such as memory protection features, oscillator selection, etc., that must be selected at programming time. If the MPQ offers the ability to program these options for the device being programmed, an "Options" button will be displayed in the Program Manager window. Clicking on the Options button will open a second window which allows the available options to be selected. These option windows are discussed in detail in the appendix for each device family.

2.7 Reading Images from Target Devices

It is possible to read images from programmed target devices and store them in an image bank on the MPQ. This is useful if you desire to copy the contents of a given device for the purpose of programming other devices. NOTE that it is only possible to read a valid image from a device which has had its protection fuses programmed to prevent the reading of its internal memory. Images read from a device which has been programmed for security will not be valid.

To read an image from a programmed, unprotected device, open the Image Manager Window, and select the image bank which you would like to receive the image to be read. The select *Image/Read Image from Target* from the MP Manager menu bar. This will invoke the Read Image from Target dialog box. This dialog allows you to select the target port from which the image will be read, and to set the programming parameters for the image. Note that the device, target voltage and programming mode selections you choose for the image will also be used when reading the image from the target device. You may also enter a name for the new image. Once you have made your selections, click the Read Image button to read the device and program the image into MPQ Flash. While the image is being read, status will be displayed in the Target Port frame.

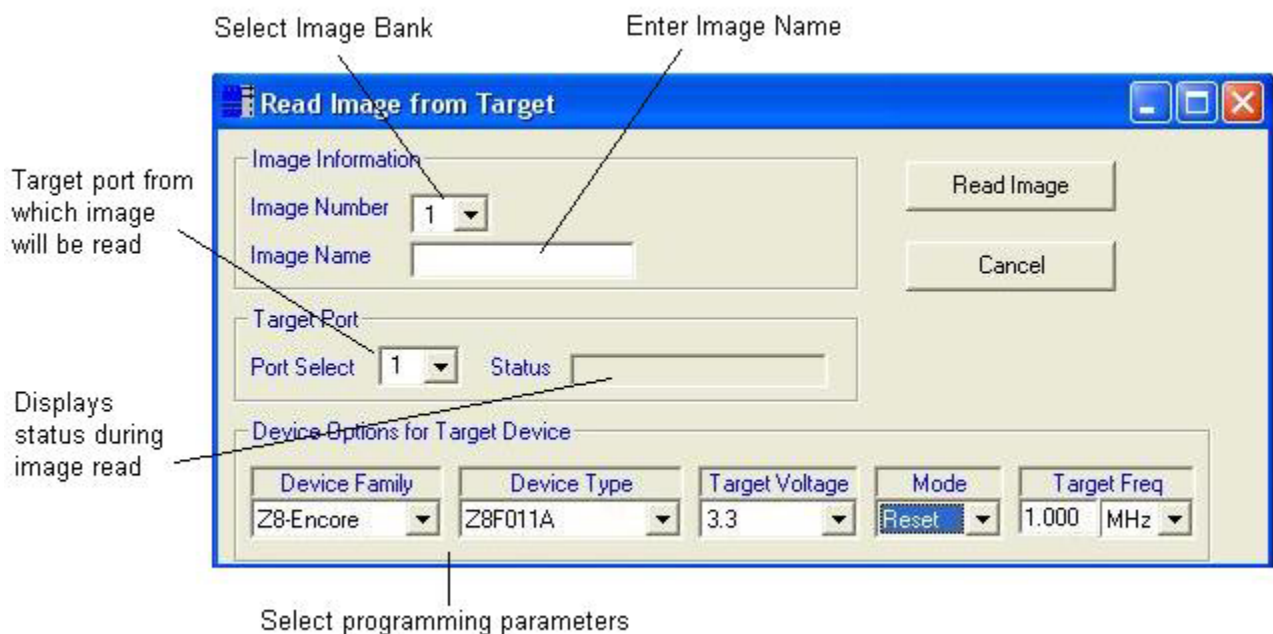

2.8 Uploading Images from MPQ

An image stored in any of MPQ's four image banks may be uploaded and stored in a file on the host PC. To upload an image, open the Image Manager, select the image you would like to upload, then select *Image/Save Image to File* from the MP Manager menu bar. This will open a file browse box, allowing you to specify a file to receive the uploaded image. When you click Save in the Browse box, Image Manager will display status and a progress bar as the image is uploaded from the programmer. The image will be stored on the PC as a standard Intel Hex file.

2.9 Array Programming from MP Manager

MPQ programmers can be connected together in arrays, allowing multiple programmers to be managed together, for simultaneous programming of up to 64 devices. Images are loaded into each MPQ, as described previously, and the Array Program Manager is used to control the programming on multiple MPQ's simultaneously. In order to access multiple MPQ's from the Array Program Manager, they must be interconnected using the RS-485 communications bus (see section 5), which allows multiple programmers to share a single PC communications port.

The first step in array programming is to load target images into all of the programmers in the array, using the Image Manager as previously described. Next, invoke the Array Program Manager using the toolbar button. In the Array Program Manager window, you will be presented with a list of all available programmers connected to the system (as determined by the last Scan for Programmers operation). You will be able to select which programmers will be included in the array programming operation by clicking the check box on the left side of each programmer frame. You will also be able to enable or disable individual ports on each programmer, just as you can from the Programming Manager. Finally, you will be able to select the desired image bank for each programmer. Once you have selected the desired parameters, simply click the Program button to initiate programming of the entire array.

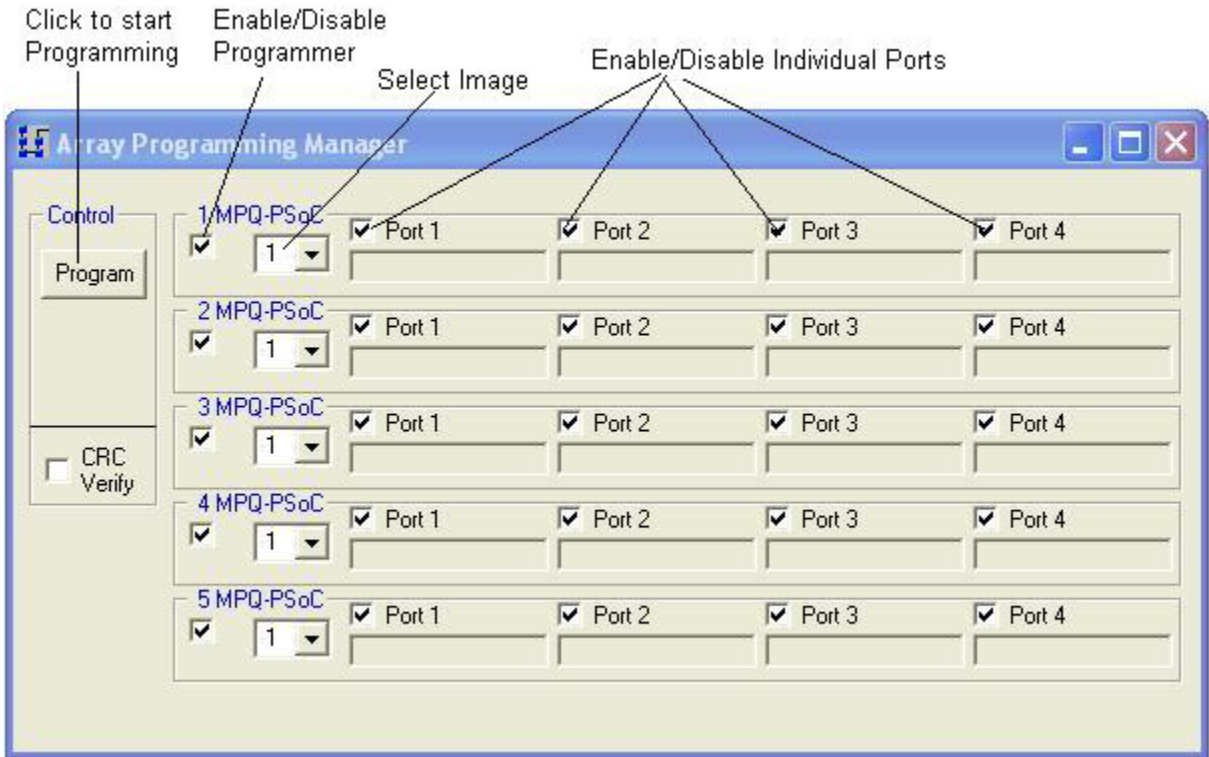

3.0 Stand-alone Device Programming

Once MP Manager has been used to load an image or images into the MPQ's internal Flash, devices may be programmed without the need for a host PC connection. First, use MP Manager to load images into programmer Flash, and to make default image and port enable selections as described in the following section. MPQ may then be disconnected from the host PC and used in stand-alone operation.

For stand-alone operation, provide power to the MPQ using the MPQ-PS power supply, and connect the Target cable to the target system(s). A programming cycle is initiated by pressing the green button on the MPQ. The programming steps taken by the MPQ are identical in stand-alone mode to those taken in PC-connected mode. Final programming status will be displayed on the status LEDs upon completion of programming. In stand-alone mode, without the host PC connected for detailed error reporting, only the LED pass/fail status is available.

Stand-alone operation can also be used with MPQ arrays to program up to 64 devices simultaneously. MPQ arrays are discussed in Section 5.

3.1 Default Image and Port Enable Selections

To prepare the MPQ for stand-alone ("push-button") operation, MP Manager must be used to select a default programming image and port-enable selection. To select these options, invoke the Programming Manager, and select the image number and the port-enables you would like to have enabled during stand-alone operation, just as if you were preparing to program from MPManager. For those device families which support CRC Verify or Checksum Verify, this option should also be selected at this time if it is desired for stand-alone programming.

Once you have selected the desired image and port-enable parameters for stand-alone operation, select *Configure/Set Defaults* from the MP Manager menu bar. This will cause your selections to be loaded and stored in the MPQ, and used as the default settings for stand-alone operations.

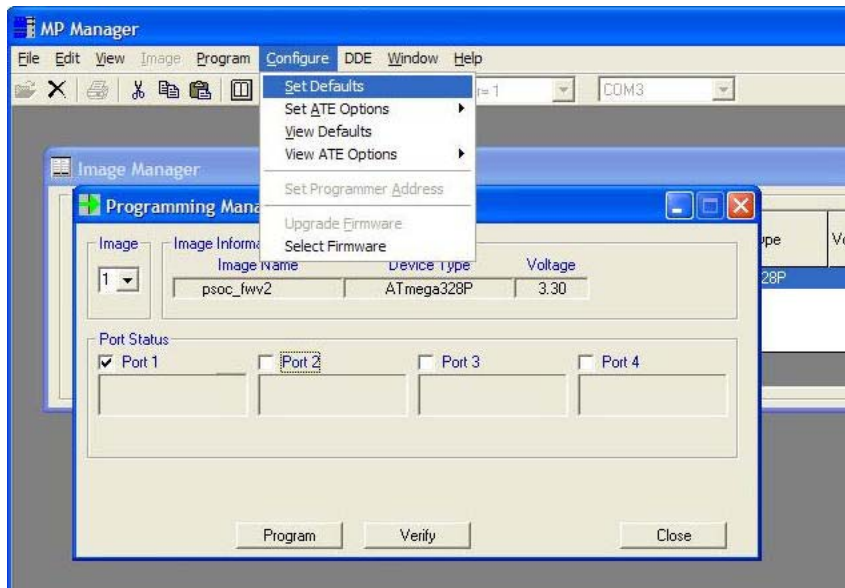

Set Pushbutton Defaults

If, at any time, you would like to view the default settings currently programmed into an MPQ, connect to the MPQ, open the Program Manager, then select the Configure/View Defaults option from MP Manager menu bar. Note that the default settings do not affect operations which are performed in PC-Controlled mode, using MP Manager.

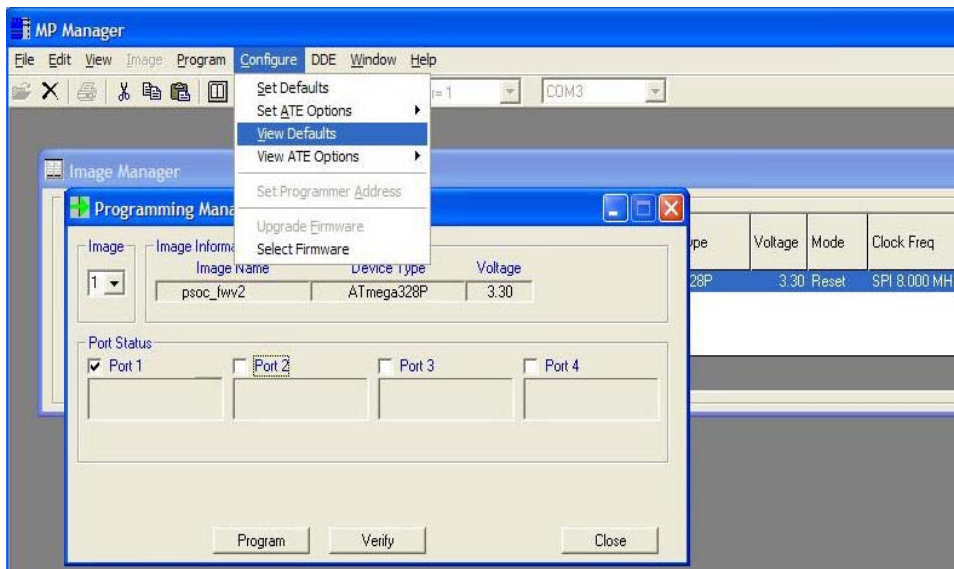

View Pushbutton Defaults

4.0 Interfacing MPQ with Automated Test Equipment

The Control connector provides signals which can be used by Automated Test Equipment (ATE) to manage device programming using the MPQ. ATE control can be extremely simple, involving the use of only one logic-level signal. Additional logic signals may be used to provide the ATE with the capability to select different image and port selection options, and to monitor pass/fail status.

The ATE control signals work in conjunction with settings programmed into the MPQ by MPManger. The ATE may use the Default setting, described in the previous section, or one of four optional ATE settings.

4.1 Control Connector Signal Description

Table 4-1 MPQ Control Connector Pins			
Pin Name	Pin #	Direction	Description
RxD	2	Input	RS-232 Serial Receive Data
TxD	3	Output	RS-232 Serial Transmit Data
D+	1	BiDir	RS-485 Serial Data bus
D-	14	BiDir	
ATE_Op_En#	8	Input	ATE Option Select Enable (Low True)
OptionSel0#	9	Input	ATE Option Select
OptionSel1#	21	Input	
CommSel	10	Input	Select RS-232 or RS-485 Communications
Active#	23	BiDir	Program Start Input / Programming Active Status (Low True)
PF1	13	Output	Pass/Fail Status - Port 1
PF2	25	Output	Pass/Fail Status - Port 2
PF3	12	Output	Pass/Fail Status - Port 3
PF4	24	Output	Pass/Fail Status - Port 4
GND	5,7,15,11,22	-	Signal Ground
n/c	4,16	-	No Connection
DNC-Out	6,17,18,19	Output	Reserved outputs. Do not connect to external circuitry
DNC-In	20	Input	Reserved input. Do not connect to external circuitry

Table 4-1 MPQ Control Connector Pins

4.1.1 Active# Control

Programming cycles can be initiated and monitored using only a single signal, *Active#*, on the MPQ Control connector. This requires two connections between the ATE and MPQ: the *Active#* signal and GND. *Active#* is a low-true, logic-level, open-drain signal. It is pulled to its inactive state internally with a 4.75K-ohm resistor to 3.3V. Driving this pin to GND externally for 10mS or more will cause a programming cycle to be initiated. The signal will then be held low by the MPQ until the programming cycle has completed. The MPQ will not initiate another programming cycle until *Active#* has first returned to the high state. That is, it is necessary for the ATE to release the *Active#* signal after the start of programming, allowing it to return high upon the

MPQ Manufacturing Programmer User's Guide

completion of programming, before another programming cycle may be initiated. The programming cycle will be run on all enabled ports of the MPQ. The default image and port-enable information will be used for programming unless ATE image selection is employed (section 4.1.3).

Active# is an open-drain signal. Current should never be sourced into this pin by the ATE device, and this pin should never be driven below GND potential.

Active# ATE control can also be used with MPQ Arrays, as described in Section 5.

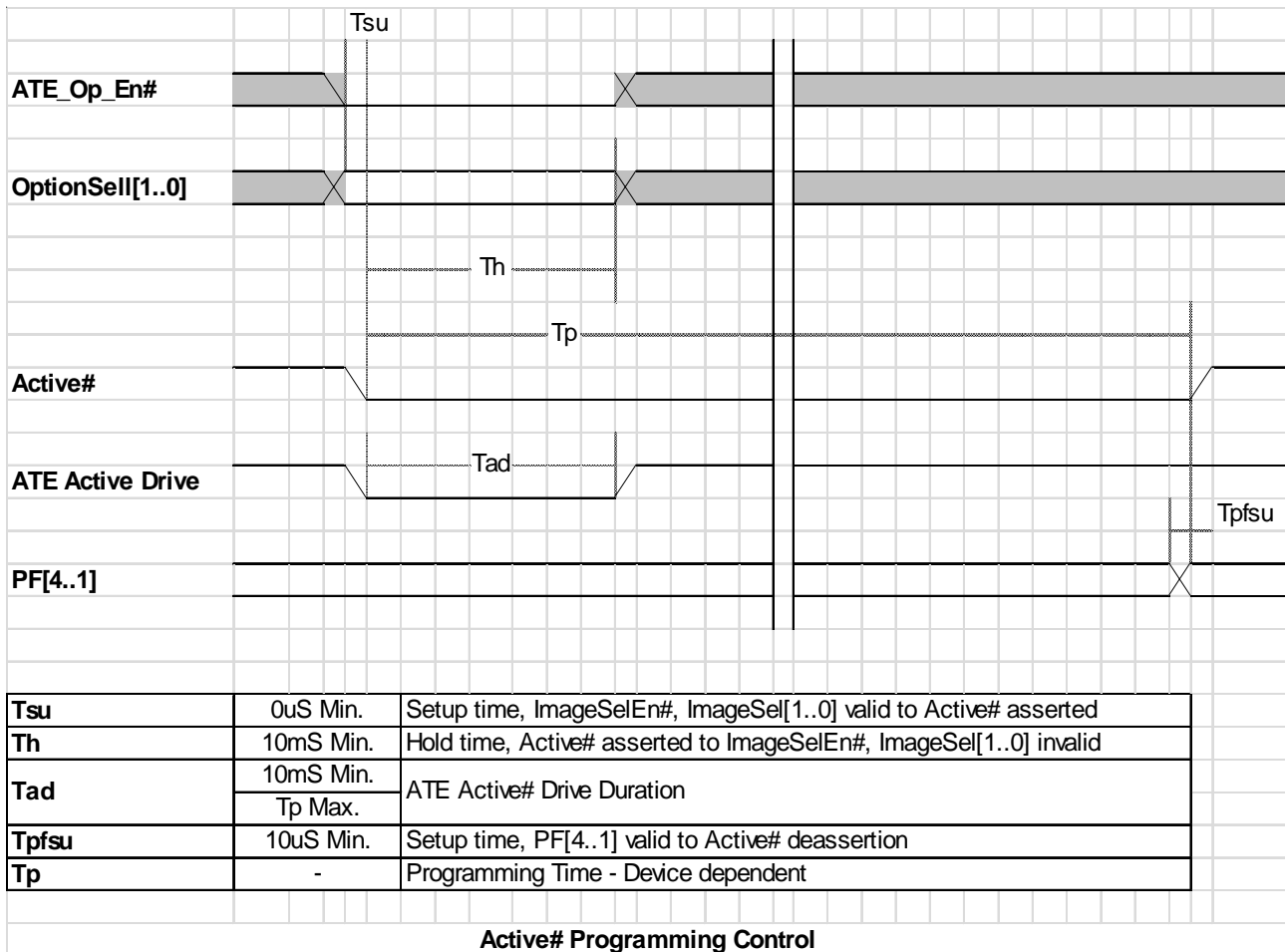

4.1.2 ATE Pass/Fail Status

At the completion of programming, pass/fail status is available on pins PF1 .. PF4 of the Control connector. The pins will be drive high (~3.3V) by the MPQ to indicate a PASS condition, or low to indicate a FAIL

MPQ Manufacturing Programmer User's Guide

condition. PF1..PF4 are valid on the rising edge of Active#.

The PF1..PF4 signals have an output resistance of approximately 100 ohms. Excessive loading on these pins should be avoided, and they should not be driven by the ATE.

4.1.3 ATE Option Selection

When programming is initiated using only Active#, the image and port selections are limited to the Default selections that were made using MP Manager. However, it is possible for the ATE to control image and port-enable selection more directly by using the ATE_Op_En# signal. If the ATE_Op_En# signal on the Control connector is asserted (low) when Active# is asserted by the ATE, the MPQ will use the information provided on the ATE_OptionSel 1..0 pins of the control connector to select the programming options. This allows four additional option settings, in addition to the Default setting.

ATE_Op_En# and ATE_OptionSel 1..0 are pulled up with 4.75K-ohm resistors to 3.5V internal to MPQ, so if they are not driven by the ATE, the default image will be used.

ATE_Op_En#	1	0	0	0	0
OptionSel1	x	0	0	1	1
OptionSel0	x	0	1	0	1
Option Selected	Default	3	2	1	0
ATE Option Selections					

4.1.4 ATE Option Setup

The four ATE option settings are programmed from MPManager in the same way that the Default setting is programmed. In the Program Manager, select the desired image and port enables, then select *Configure/Set ATE Options* from the MPManager menu bar. You will be given the choice of one of the four ATE Options to be used for the setting. The existing ATE Option settings can also be viewed by selecting *Configure/View ATE Options* from the MPManager menu bar.

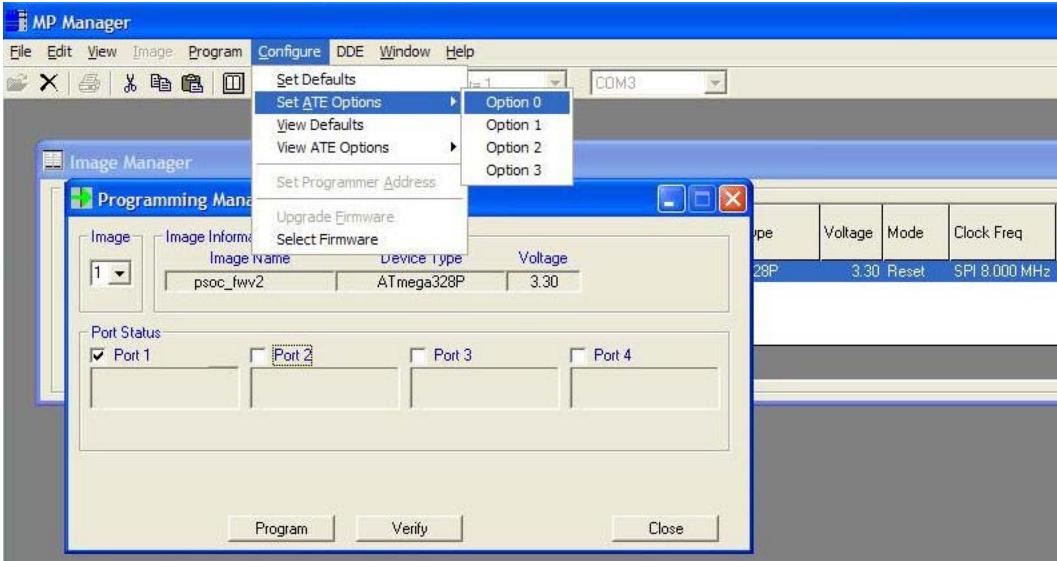

Set ATE Options

5.0 MPQ Arrays

MPQ programmers can be arranged in arrays - essentially networked together - in a variety of ways in order to provide the ability to control all the programmers in the array with one set of control inputs. Arrays can be used in Stand-alone, ATE and PC-Controlled operating modes.

5.1 Stand-Alone Arrays

To use stand-alone MPQ arrays, it is necessary only to connect together the GND and Active# signals of all programmers in the array. Pressing the green programming button on any one of the MPQs will then initiate a programming cycle on all MPQs in the array. Each MPQ will display pass/fail status for its four ports on its own Pass/Fail LED displays. Under normal circumstances, the image and port enables selected for the array operation will be the Default image selected for each programmer by MP Manager (section 3.1), however the ATE control signals can also be used to select different programming options, as described in the preceding section on ATE-controlled programming.

5.2 ATE Controlled Arrays

ATE controlled arrays can be constructed by connecting together the GND and Active# signals of all programmers in the array. The ATE may then drive the shared Active# low to initiate a programming cycle on all programmers in the array. Note that, since each MPQ provides an internal 4.75K-ohm pullup resistor, the amount of current required from the ATE to assert the Active# signal increases with the number of programmers in the array. The minimum sink current required to assert Active# in an array of 16 programmers is approximately 10mA.

Once the programming cycle is initiated, Active# will be held low until all programmers in the array have completed their programming cycles.

If ATE image selection is desired, the ATE_Op_En# and OptionSel1..0 signals of the programmers in the array may be interconnect, as well, and driven by the ATE as described in section 4.1.3.

If the ATE needs to acquire pass/fail status from the programmers in the array, the PF1..4 status outputs from each MPQ in the array must be acquired independently - as a separate ATE input - as each output applies to a specific target port.

5.3 PC-Controlled Arrays

In order to control arrays from the PC, using MP Manager, the PC must be able to communicate with all of the programmers in the array. This is enabled by using the MPQ's built-in RS-485 communications bus. Essentially, the D+, D- and GND signals of each of the programmers in the array are connected together with

MPQ Manufacturing Programmer User's Guide

the D+, D- and GND signals, respectively, of the other programmers in the array. This is facilitated by the use of the USB Array Interconnect Board, RPM p/n MPQ-AIB-USB, which provides the RS-485 interconnect capability via ribbon cable connectors, as well as an RS-485 to USB interface converter, which allows the entire array to be directly controlled from a standard PC USB port.

It should be noted that the Active# lines of the multiple programmers should not be connected together in PC-controlled arrays, as they are in stand-alone or ATE-controlled arrays. In PC-controlled arrays, the programming cycle is initiated and monitored on each programmer independently by MP Manager.

Appendix A - Cypress PSoC Microcontrollers

This appendix provides details of connection and operation of the MPQ programmer for Cypress Semiconductor PSoC microcontrollers.

A.1 Device Options

The Device Options in the Load Image and Read Image windows allow the operator to select the device type, operating voltage and programming mode for the image being loaded into MPQ Flash.

MPQ-PSoC supports the Cypress Semiconductor PSoC and CapSense Device Families.

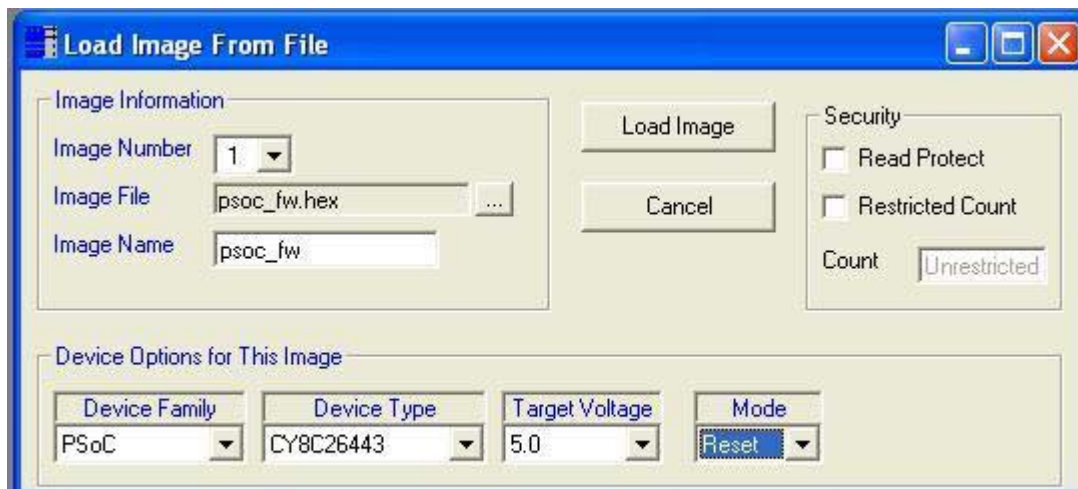

Cypress PSoC Device Options

A.1.1 Device Type

Device Type identifies the particular manufacturer's part number of the PSoC device for which the image being loaded is intended. Select the proper device from the dropdown list. MPQ will use this information prior to programming to verify the device ID in the part to be programmed.

A.1.2 Target Voltage

Select the voltage at which the target system will be operating during the programming of the device. MPQ will use this information to verify that the target power is at the proper level before beginning the programming

operation.

A.1.3 Mode

Cypress PSoC devices can be programmed in either of two modes, Reset mode or Power-on mode. 8-pin devices only support the power-on mode. Unless you are using an 8-pin device, or have a specific reason to use Power-on mode (e.g., the CPU Reset signal is not wired on the programming connector), RPM recommends the use of Reset mode. Power-on mode requires that target system power be off at the start of each programming cycle. Reset programming mode will function whether programming is initiated with target power on or off.

In Power-on programming mode, a power cycle is required to gain control of the target devices for programming. In this case, if power is detected on an enabled port when programming is initiated, programming will fail. The target system(s) must be powered off before starting the programming cycle. The following steps are taken during the programming cycle:

- verify target power off (Power-On programming only)
- wait for target power valid
- program devices
- verify devices
- program security bits

A.2 Programming Options

No programming options are supported for the Cypress PSoC devices. The setting of the memory protection bits is defined by the Cypress PSoC Development Tools, and stored in the program image produced by that software.

A.3 PSoC Target Cable Connections

The Target Cable assembly provides the connection between the programmer and the four target boards. The Target Cable provides connections to the standard 5-pin Molex connector used by Cypress Semiconductor on their development and programming boards (Molex P/N 22-23-2051). The customer may request an optional Target Cable assembly which provides bare leads on the target ends of the cable assembly, allowing the customer to produce custom interconnects which are compatible with a given manufacturing or development setup. The following table shows the pin assignments for the various connectors. One Target Cable assembly provides four sets of target programming signals.

MPQ-PSoC Target Cable Connections					
	MPQ Target Connector Pin #	Signal Name	Signal Description	Wire Color	Molex Pin #
	1	-	Not Used		
Target Port 1	2	Vcc	Target Vcc	Red	1
	3	SCLK	Programming Clock	Blue	4
	4	SDATA	Programming Data	White	5
	5	XRES	Target Device Reset	Yellow	3
	6	-	Not Used	-	
	7	-	Not Used	-	
	8	GND	Target GND	Black	2
Target Port 2	9	Vcc	Target Vcc	Red	1
	10	SCLK	Programming Clock	Blue	4
	11	SDATA	Programming Data	White	5
	12	XRES	Target Device Reset	Yellow	3
	13	-	Not Used	-	
	14	-	Not Used	-	
	15	GND	Target GND	Black	2
Target Port 3	16	Vcc	Target Vcc	Red	1
	17	SCLK	Programming Clock	Blue	4
	18	SDATA	Programming Data	White	5
	19	XRES	Target Device Reset	Yellow	3
	20	-	Not Used	-	
	21	-	Not Used	-	
	22	GND	Target GND	Black	2
Target Port 4	23	Vcc	Target Vcc	Red	1
	24	SCLK	Programming Clock	Blue	4
	25	SDATA	Programming Data	White	5
	26	XRES	Target Device Reset	Yellow	3
	27	-	Not Used	-	
	28	-	Not Used	-	
	29	GND	Target GND	Black	2
	30	-	Not Used		

NOTE: The GND signal must be common amongst the four target ports when connected to the programmer. All GNDs are tied together internal to MPQ.

Appendix B - Zilog Z8 Encore! and ZLF645

This appendix provides details of connection and operation of the MPQ programmer for Zilog Z8 Encore! microcontrollers.

B.1 Device Options

MPQ-Z8 supports Zilog Z8-Encore! and ZLF645 device families.

The Device Options in the Load Image and Read Image windows allow the operator to select the device type, operating voltage and programming mode for the image being loaded into MPQ Flash.

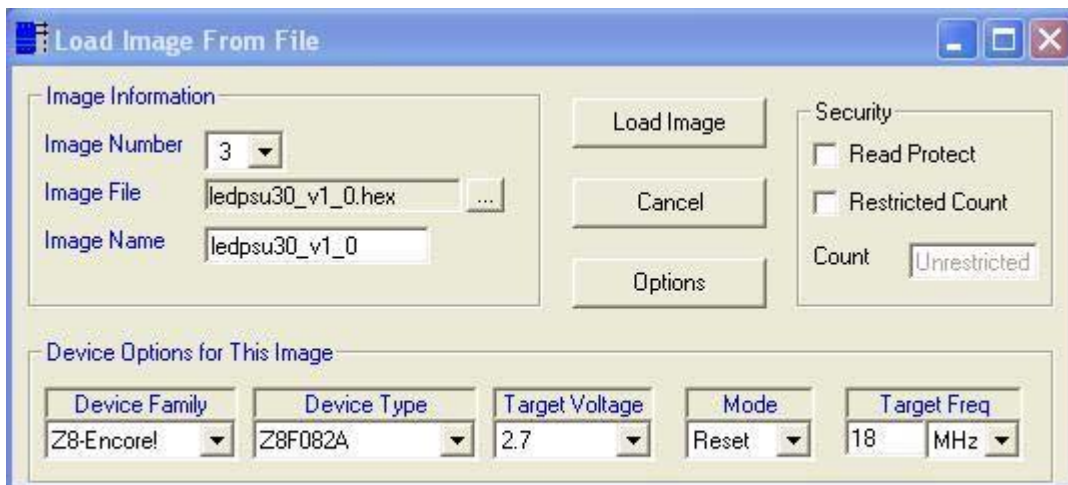

Z8 Encore! Device Options

B.1.1 Device Type

Device Type identifies the particular manufacturer's part number of the device for which the image being loaded is intended. Select the proper device from the dropdown list. MPQ will use this information prior to programming to verify the device ID in the part to be programmed.

B.1.2 Target Voltage

Select the voltage at which the target system will be operating during the programming of the device. MPQ will use this information to verify that the target power is at the proper level before beginning the programming

operation. The selection of target voltages available in the dropdown list will depend upon the particular device selected in "Device Type", so make the device type selection first.

B.1.3 Mode

There are two Mode selections available for Z8 Encore, "Reset" and "Run". The Mode selection determines whether the target system will be held in reset at the completion of a program cycle ("Reset"), or be reset and then permitted to begin code execution ("Run").

B.1.4 Target Frequency

Enter the clock frequency of the target system as it will be when the device is being programmed. This information is used by the MPQ to determine the frequency of the programming clock, which is limited by the frequency of the CPU clock in the target. Note that slower target clock frequencies will result in longer programming times. MPQ will support target clock frequencies as low as 32KHz, but it is recommended that the target clock frequency during programming be at least 1MHz in order to avoid excessively long programming times.

B.1.5 Special Considerations for 8-pin and Crimson Parts

Certain members of the Z8 Encore! and ZLF645 Crimson family require special consideration during in-system programming. In particular, these parts do not provide an external Reset capability. They must therefore be programmed starting from a power-off condition. That is, when programming is initiated from MPManager or from programmer hardware (ATE or push-button), target power must be off. Power must then be applied to the target within 10 seconds of initiating programming.

B.2 Programming Options

The Z8-Encore! family offers a variety of programming options which can be selected via MP Manager when the image is loaded into the programmer. From the "Load Image from File" window, click the "Options" button to open the Z8 Encore Options window. Select the programming options prior to clicking the "Load Image" button.

The parameters that can be modified in this window are device dependent, so be certain to select the target device from the "Device Type" dropdown list before opening the Options window.

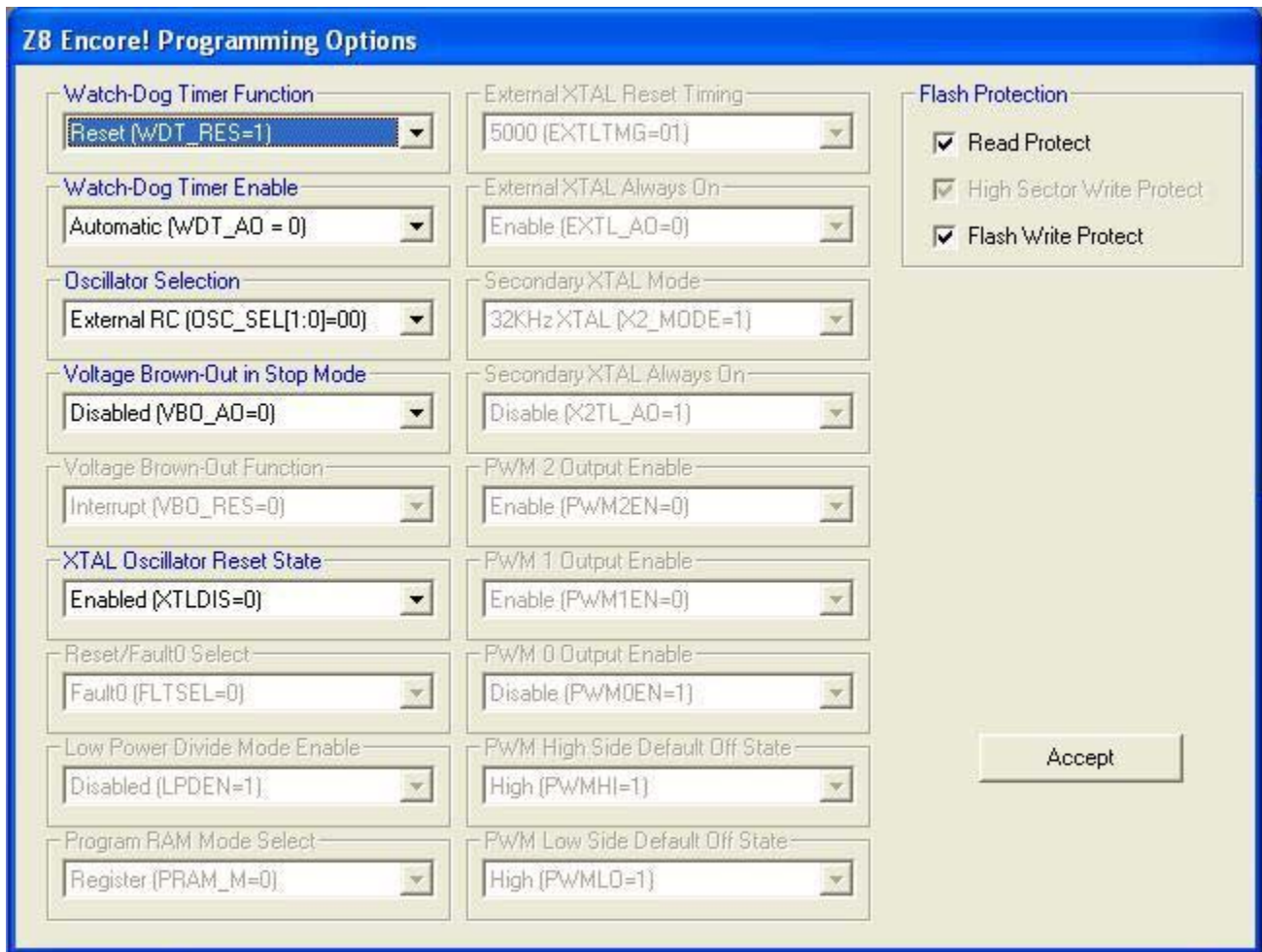

Z8 Encore! Programming Options

B.3 - Target Cable Connections

The Target Cable assembly provides the connection between the programmer and the four target boards. The Target Cable provides connections to the 6-pin DBG connector used by Zilog on their development and evaluation boards. The customer may optionally request bare leads on the target ends of the cable assembly, allowing the customer to produce custom interconnects which are compatible with a given manufacturing or development setup. The following table shows the pin assignments for the various connectors. One Target Cable assembly provides four sets of target programming signals.

The following drawing shows the target system connections required for programming of devices on the

MPQ Manufacturing Programmer User's Guide

Z8-Encore! target board using the MPQ. Connection of the RESET signal is optional but recommended.

MPQ-Z8 Target Cable Connections					
	MPQ Target Connector Pin #	Signal Name	Signal Description	Wire Color	Zilog DBG Pin #
	1	-	Not Used		
Target Port 1	2	Vcc	Target Vcc	Red	1
	3	-	Not Used	-	
	4	DBG	Target Debug signal	Yellow	4
	5	RESET	Target Device Reset	Violet	2
	6	-	Not Used	-	
	7	-	Not Used	-	
	8	GND	Target GND	Black	3
Target Port 2	9	Vcc	Target Vcc	Red	1
	10	-	Not Used	-	
	11	DBG	Target Debug signal	Yellow	4
	12	RESET	Target Device Reset	Violet	2
	13	-	Not Used	-	
	14	-	Not Used	-	
	15	GND	Target GND	Black	3
Target Port 3	16	Vcc	Target Vcc	Red	1
	17	-	Not Used	-	
	18	DBG	Target Debug signal	Yellow	4
	19	RESET	Target Device Reset	Violet	2
	20	-	Not Used	-	
	21	-	Not Used	-	
	22	GND	Target GND	Black	3
Target Port 4	23	Vcc	Target Vcc	Red	1
	24	-	Not Used	-	
	25	DBG	Target Debug signal	Yellow	4
	26	RESET	Target Device Reset	Violet	2
	27	-	Not Used	-	
	28	-	Not Used	-	
	29	GND	Target GND	Black	3
	30	-	Not Used		

NOTE: The GND signal must be common amongst the four target ports when connected to the programmer. All GNDs are tied together internal to MPQ.

Appendix C - Cypress enCoRe II Microcontrollers

This appendix provides details of connection and operation of the MPQ programmer for Cypress Semiconductor enCoRe II microcontrollers.

Note that the enCoRe II family supports only one programming mode, power-on programming, which requires the programmer to acquire control of the microcontroller immediately upon application of power. For this reason, it is necessary when programming these devices for the user to initiate programming prior to providing power to the target system. Once programming has been initiated, the programmer will wait up to ten seconds for power to be detected on all enabled ports before beginning the program cycle (see section C.4 for a discussion of the USB Powered Interface Option).

C.1 Device Options

The Device Options in the Load Image and Read Image windows allow the operator to select the device type and operating voltage the image being loaded into MPQ Flash.

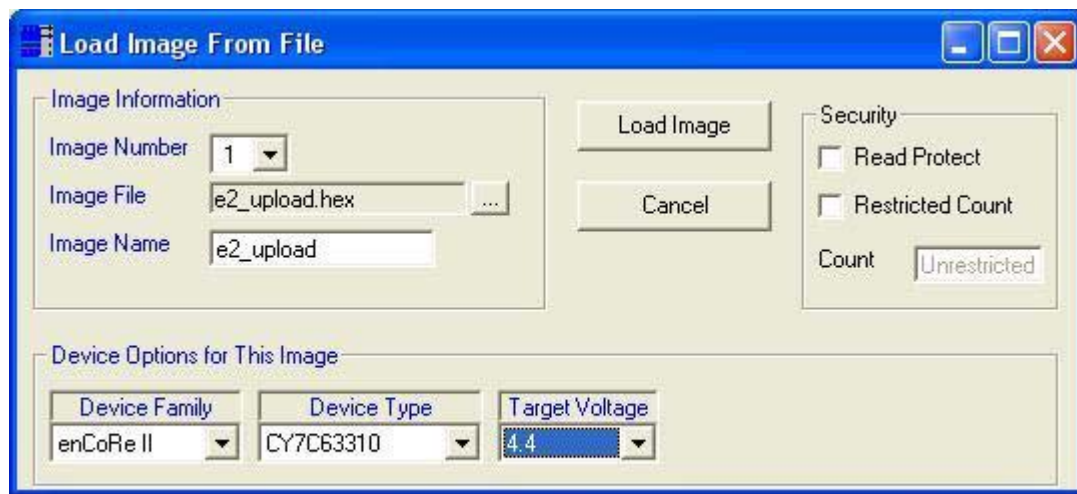

Cypress enCoRe II Device Options

"enCoRe II" is the only Device Family supported by this programmer.

C.1.1 Device Type

Device Type identifies the particular manufacturer's part number of the enCoRe II device for which the image being loaded is intended. Select the proper device from the dropdown list. MPQ will use this information prior to programming to verify the device ID in the part to be programmed.

C.1.2 Target Voltage

Select the voltage at which the target system will be operating during the programming of the device. MPQ will use this information to verify that the target power is at the proper level before beginning the programming operation.

C.2 Programming Options

No programming options are supported for the Cypress enCoRe II devices. The setting of the memory protection bits is defined by the Cypress PSoC Development Tools, and stored in the program image produced by that software.

C.3 enCoRe II Target Cable Connections

The Target Cable assembly shipped with MPQ-E2 is terminated to mate with the standard 5-pin Molex connector used by Cypress on their development and programming boards (Molex P/N 22-23-2051). In addition, the Powered USB Interface Option (PUIO - see section C.4) allows USB-powered enCoRe II designs to be powered and programmed via the USB connection. The drawing below shows a connections for both the USB and the 5-pin programming connector. Only the connections necessary for programming are shown. Note that, if the PUIO is used for programming via the USB, the 5-pin programming connector is not required.

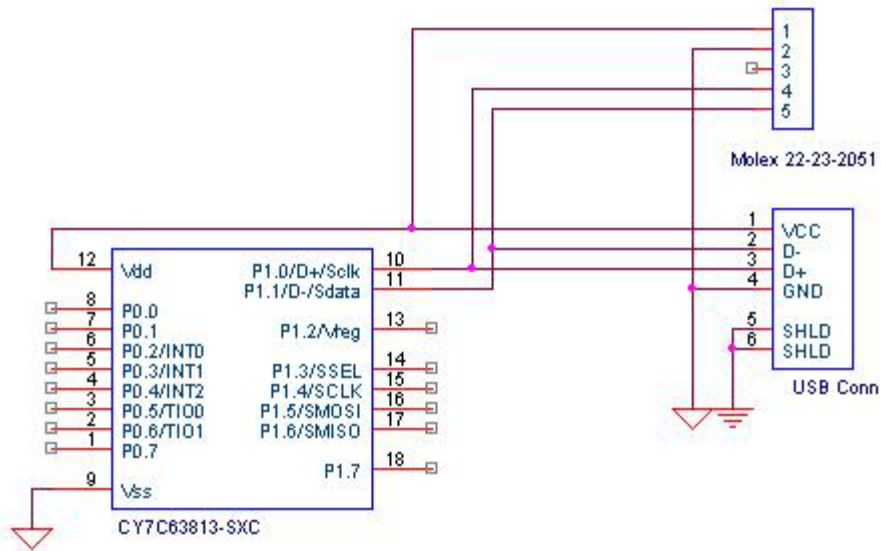

The following table shows the pin assignments for the various connectors. One Target Cable assembly provides four sets of target programming signals.

MPQ-E2 Target Cable Connections					
	MPQ Target Connector Pin #	Signal Name	Signal Description	Wire Color	Molex Pin #
	1	-	Not Used		
Target Port 1	2	Vcc	Target Vcc	Red	1
	3	SCLK	Programming Clock	Blue	4
	4	SDATA	Programming Data	White	5
	5	-	Reserved	-	
	6	-	Reserved	-	
	7	-	Reserved	-	
	8	GND	Target GND	Black	2
Target Port 2	9	Vcc	Target Vcc	Red	1
	10	SCLK	Programming Clock	Blue	4
	11	SDATA	Programming Data	White	5
	12	-	Reserved	-	
	13	-	Reserved	-	
	14	-	Reserved	-	
	15	GND	Target GND	Black	2
Target Port 3	16	Vcc	Target Vcc	Red	1
	17	SCLK	Programming Clock	Blue	4
	18	SDATA	Programming Data	White	5
	19	-	Reserved	-	
	20	-	Reserved	-	
	21	-	Reserved	-	
	22	GND	Target GND	Black	2
Target Port 4	23	Vcc	Target Vcc	Red	1
	24	SCLK	Programming Clock	Blue	4
	25	SDATA	Programming Data	White	5
	26	-	Reserved	-	
	27	-	Reserved	-	
	28	-	Reserved	-	
	29	GND	Target GND	Black	2
	30	-	Not Used		

NOTE: The GND signal must be common amongst the four target ports when connected to the programmer. All GNDs are tied together internal to MPQ.

C.4 Powered USB Interface Option

The Powered USB Interface Option (PUIO) facilitates programming of enCoRe II products which are USB-powered. Since these products derive their power from the USB, and the USB D+ and D- data signal wires are used for in-system programming, the PUIO is a convenient member, 2010 provide 36 both power and signal access to these designs. The PUIO also precludes the requirement for a separate programming connector on the target board. The PUIO is a separate element which is connected between the

MPQ Manufacturing Programmer User's Guide

MPQ and the target systems. It connects to the MPQ via a short control cable, and provides four Type A USB connections for the four target systems. The PUIO has its own fixed 5V power supply, and is capable of providing up to 100mA to each of the four target boards. When a programming cycle is initiated, the PUIO, under the control of the MPQ, automatically provides power to the four target systems, and removes power when programming is complete.

Appendix D - Silicon Labs C8051F3xx Microcontrollers

This appendix provides details of connection and operation of the MPQ programmer for Silicon Labs C8051F3xx microcontrollers.

D.1 Device Options

The Device Options in the Load Image and Read Image windows allow the operator to select the device type, operating voltage and programming mode for the image being loaded into MPQ Flash.

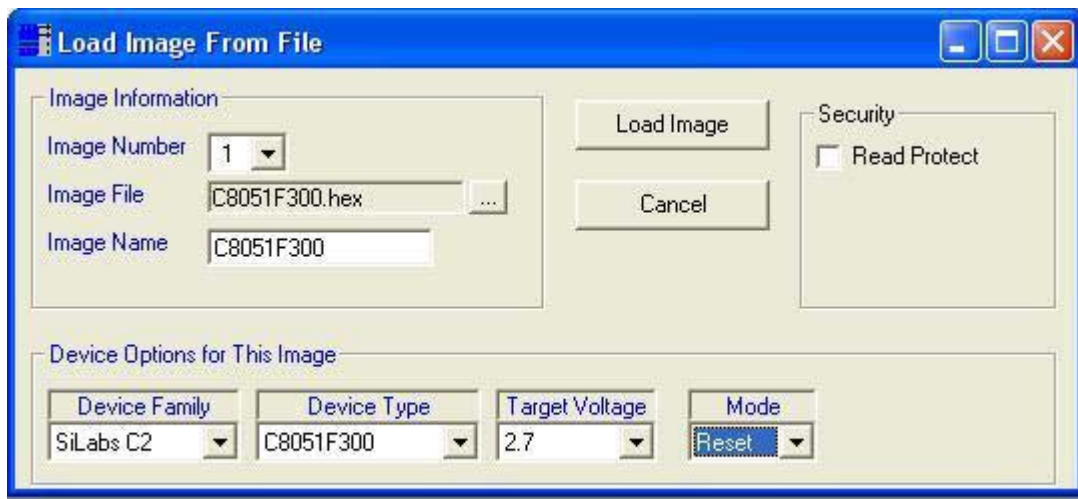

Silicon Labs C8051F3xx Device Options

"SiLabs C2" is the only Device Family supported by this programmer.

D.1.1 Device Type

Device Type identifies the particular manufacturer's part number of the C8051F3xx family device for which the image being loaded is intended. Select the proper device from the dropdown list. MPQ will use this information prior to programming to verify the device ID in the part to be programmed.

D.1.2 Target Voltage

Select the voltage at which the target system will be operating during the programming of the device. MPQ will use this information to verify that the target power is at the proper level before beginning the programming operation.

D.1.3 Mode

There are two Mode selections available for C8051F3xx, "Reset" and "Run". The Mode selection determines whether the target system will be held in reset at the completion of a program cycle ("Reset"), or be reset and then permitted to begin code execution ("Run").

D.2 Programming Options

No programming options are supported for the C8051F3xx family devices.

D.3 Silicon Labs C8051F3xx Target Cable Connections

The Target Cable assembly shipped with MPQ-C2 is terminated to mate with the standard 10-pin connector used by Silicon Labs on their development boards. The drawing below shows the connections required between the programming connector and the microcontroller. The MPQ supports the pin sharing signal isolation connections defined by Silicon Labs in their product data sheets and in their Application Note AN124. The values of the isolation resistors, if used, will be design dependent, but should be no lower than 1.0 Kohm. If pin sharing isolation is not required in a given design, it is not necessary to include the isolation resistors, and the *iso_c2d* and *iso_c2ck* connections may be omitted.

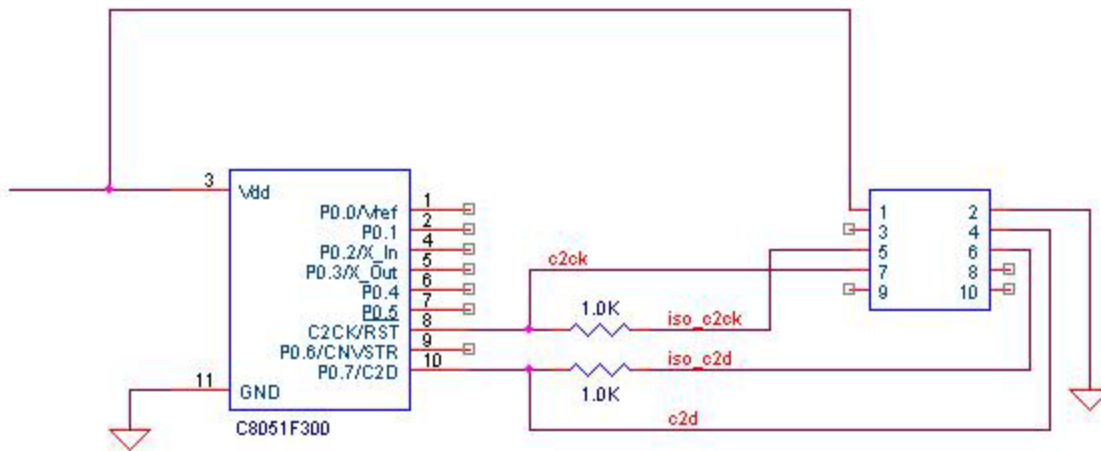

MPQ Manufacturing Programmer User's Guide

The following table shows the pin assignments for the C8051F3xx programming connectors. One Target Cable assembly provides four sets of target programming signals.

MPQ-C2 Target Cable Connections					
	MPQ Target Connector Pin #	Signal Name	Signal Description	Wire Color	Debug Pin #
	1	-	Not Used		
Target Port 1	2	Vcc	Target Vcc	Red	1
	3	C2CK	Programming Clock	Blue	7
	4	C2D	Programming Data	White	4
	5	Iso C2CK	Isolated C2 Clock	Yellow	5
	6	Iso C2D	Isolated C2 Data	Violet	6
	7	-	Not Used	-	
	8	GND	Target GND	Black	2
	Target Port 2	9	Vcc	Target Vcc	Red
10		C2CK	Programming Clock	Blue	7
11		C2D	Programming Data	White	4
12		Iso C2CK	Isolated C2 Clock	Yellow	5
13		Iso C2D	Isolated C2 Data	Violet	6
14		-	Not Used	-	
15		GND	Target GND	Black	2
Target Port 3	16	Vcc	Target Vcc	Red	1
	17	C2CK	Programming Clock	Blue	7
	18	C2D	Programming Data	White	4
	19	Iso C2CK	Isolated C2 Clock	Yellow	5
	20	Iso C2D	Isolated C2 Data	Violet	6
	21	-	Not Used	-	
	22	GND	Target GND	Black	2
Target Port 4	23	Vcc	Target Vcc	Red	1
	24	C2CK	Programming Clock	Blue	7
	25	C2D	Programming Data	White	4
	26	Iso C2CK	Isolated C2 Clock	Yellow	5
	27	Iso C2D	Isolated C2 Data	Violet	6
	28	-	Not Used	-	
	29	GND	Target GND	Black	2
	30	-	Not Used		

NOTE: The GND signal must be common amongst the four target ports when connected to the programmer. All GNDs are tied together internal to MPQ.

Appendix E - Zilog ZNEO

This appendix provides details of connection and operation of the MPQ programmer for Zilog ZNEO microcontrollers.

E.1 Device Options

"ZNEO - Z16F" is the only Device Family supported by this programmer.

The Device Options in the Load Image and Read Image windows allow the operator to select the device type, operating voltage and programming mode for the image being loaded into MPQ Flash.

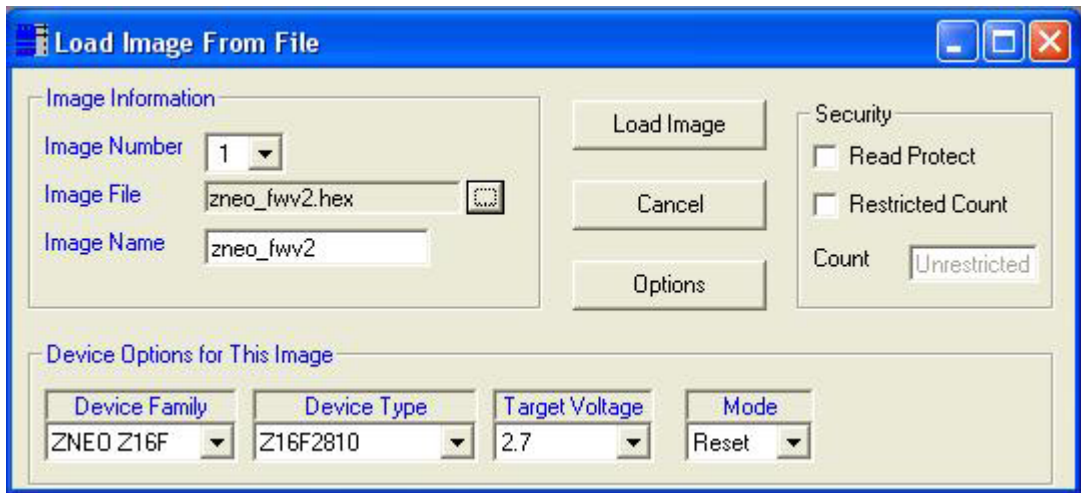

E.1.1 Device Type

Device Type identifies the particular manufacturer's part number of the device for which the image being loaded is intended. Select the proper device from the dropdown list. MPQ will use this information prior to programming to verify the device ID in the part to be programmed.

E.1.2 Target Voltage

Select the voltage at which the target system will be operating during the programming of the device. MPQ will use this information to verify that the target power is at the proper level before beginning the programming operation. The selection of target voltages available in the dropdown list will depend upon the particular device selected in "Device Type", so make the device type selection first.

E.1.3 Mode

There are two Mode selections available for ZNEO, "Reset" and "Run". The Mode selection determines whether the target system will be held in reset at the completion of a program cycle ("Reset"), or be reset and then permitted to begin code execution ("Run").

E.2 Programming Options

The ZNEO family offers a variety of programming options which can be selected via MP Manager when the image is loaded into the programmer. From the "Load Image from File" window, click the "Options" button to open the ZNEO Options window. Select the programming options prior to clicking the "Load Image" button.

The parameters that can be modified in this window are device dependent, so be certain to select the target device from the "Device Type" dropdown list before opening the Options window.

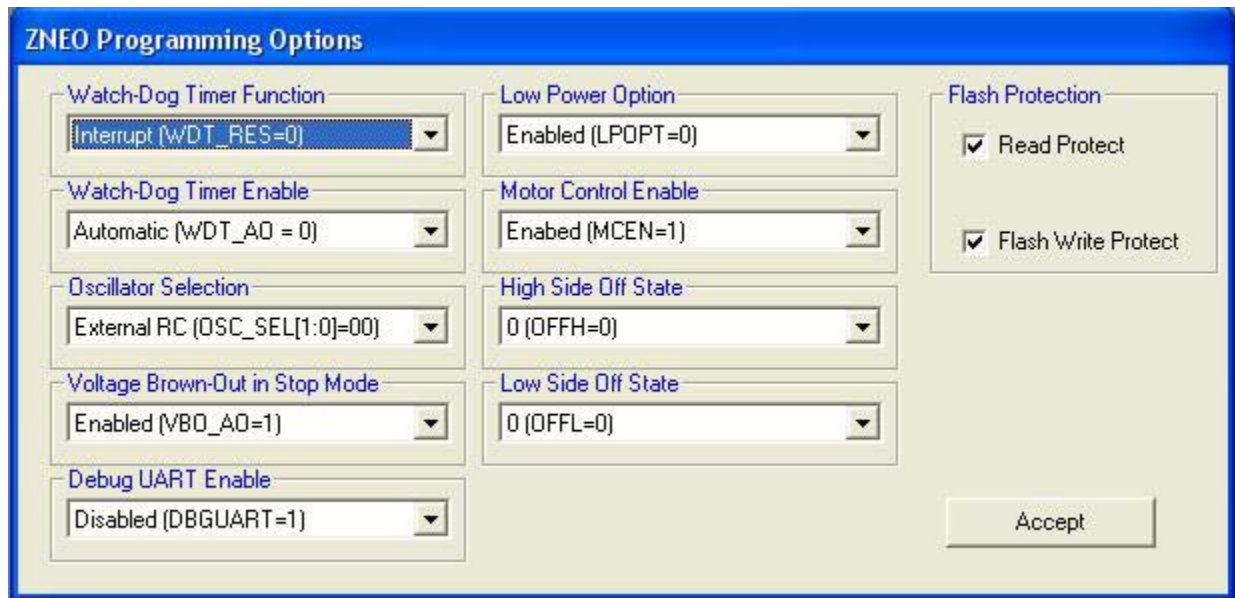

E.3 - Target Cable Connections

The Target Cable assembly provides the connection between the programmer and the four target boards. The standard assembly provides connections to the 6-pin DBG connector used by Zilog on their development and evaluation boards. Optionally, a customer may request a Target Cable assembly which provides bare leads on the target ends of the cable assembly, allowing the customer to produce custom interconnects which are compatible with a given manufacturing or development setup. The following table shows the pin assignments for the various connectors. One Target Cable assembly provides four sets of target programming signals.

	MPQ Target Connector Pin #	Signal Name	Signal Description	Wire Color	Zilog DBG Pin #
	1	-	Not Used		
Target Port 1	2	Vcc	Target Vcc	Red	1
	3	-	Not Used	-	
	4	DBG	Target Debug signal	Yellow	4
	5	RESET	Target Device Reset	Violet	2
	6	-	Not Used	-	
	7	-	Not Used	-	
	8	GND	Target GND	Black	3
Target Port 2	9	Vcc	Target Vcc	Red	1
	10	-	Not Used	-	
	11	DBG	Target Debug signal	Yellow	4
	12	RESET	Target Device Reset	Violet	2
	13	-	Not Used	-	
	14	-	Not Used	-	
	15	GND	Target GND	Black	3
Target Port 3	16	Vcc	Target Vcc	Red	1
	17	-	Not Used	-	
	18	DBG	Target Debug signal	Yellow	4
	19	RESET	Target Device Reset	Violet	2
	20	-	Not Used	-	
	21	-	Not Used	-	
	22	GND	Target GND	Black	3
Target Port 4	23	Vcc	Target Vcc	Red	1
	24	-	Not Used	-	
	25	DBG	Target Debug signal	Yellow	4
	26	RESET	Target Device Reset	Violet	2
	27	-	Not Used	-	
	28	-	Not Used	-	
	29	GND	Target GND	Black	3
	30	-	Not Used		

NOTE: The GND signal must be common amongst the four target ports when connected to the programmer. All GNDs are tied together internal to MPQ.

Appendix F - Atmel AVR

This appendix provides details of connection and operation of the MPQ programmer for Atmel AVR microcontrollers.

F.1 Device Options

The Device Options in the Load Image and Read Image windows allow the operator to select the device type, operating voltage and programming mode for the image being loaded into MPQ Flash.

MPQ-AVR supports three AVR device families: ATtiny, ATmega and AT90S series microcontrollers. The desired family is selected from the Device Family dropdown box in the Load Image or Read Image window.

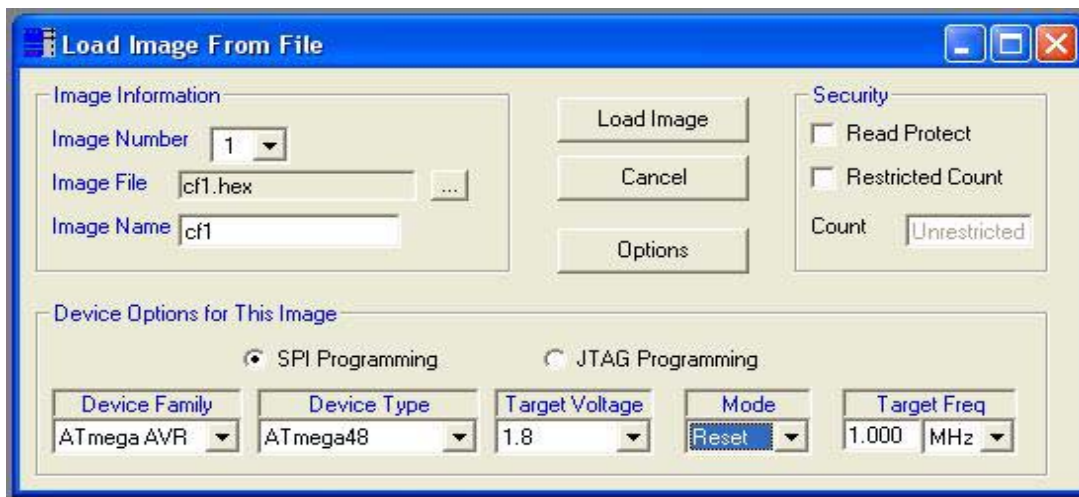

F.1.1 Device Type

Device Type identifies the particular manufacturer's part number of the device for which the image being loaded is intended. Select the proper device from the dropdown list. MPQ will use this information prior to programming to verify the device ID in the part to be programmed.

F.1.2 Target Voltage

Select the voltage at which the target system will be operating during the programming of the device. MPQ will use this information to verify that the target power is at the proper level before beginning the programming operation. The selection of target voltages available in the dropdown list will depend upon the particular device

selected in "Device Type", so make the device type selection first.

F.1.3 Mode

There are two Mode selections available for AVR, "Reset" and "Run". The Mode selection determines whether the target system will be held in reset at the completion of a program cycle ("Reset"), or be reset and then permitted to begin code execution ("Run").

F.1.4 Target Frequency

The Target Frequency must be set for SPI mode programming only. It is used to determine the maximum clock frequency at which the SPI programming interface can be run. The frequency entered here should be the operating frequency of the target microcontroller, as determined by the fuse settings and/or crystal or oscillator on the target hardware.

F.1.5 SPI/JTAG Protocol Select

Two option buttons, SPI and JTAG, in the Device Options frame allow the user to choose the which programming interface is to be used to program the image. Note that some devices do not support both interfaces and, as a result, both options may not be available.

F.2 Programming Options

The AVR family offers a variety of programming options which can be selected via MP Manager when the image is loaded into the programmer. From the "Load Image from File" window, click the "Options" button to open the AVR Options window. The options include fuse settings, optional EEPROM programming and optional OSCCAL value selection. The desired programming options must be selected prior to clicking the "Load Image" button.

The available programming options are device dependent, so be certain to select the target device from the "Device Type" dropdown list before opening the Options window. Make the desired changes in the Options window, as described below, then click Accept to return to the main Load Image window. You may open the Options window again, to make additional changes or verify values, as many times as necessary before clicking Load Image.

F.2.1 Fuse Values

The AVR fuse settings are shown in the Options window. When a device is selected, the fuse values are set to the manufacturer's default values. To modify the fuse values, click on the field that you would like to modify, and an option box will appear, enumerating the available options and allowing you to choose one.

AVR Programming Options - ATmega48

Lock Bits							
7	6	5	4	3	2	1	0
<n/u>		BLB1		BLB0		LB	
1	1	1	1	1	1	1	1

Low Fuse Byte							
7	6	5	4	3	2	1	0
CKDIV8	CKOUT	SUT:CKSEL					
0	1	1	0	0	0	1	0

High Fuse Byte							
7	6	5	4	3	2	1	0
RSTDISBL	DWEN	SPIEN	WDTON	EESAVE	BODLVL		
1	1	0	1	1	1	1	1

Extended Fuse Byte							
7	6	5	4	3	2	1	0
<n/u>							SELFPRGEN
1	1	1	1	1	1	1	1

EEPROM

Load EEPROM Image

Image File: ...

Image Name:

Write Calibration Value to Target Memory

Select Value: ▾

Flash EEPROM

Address (Hex):

F.2.2 EEPROM Programming

Most AVR devices have internal EEPROM which can be programmed by the MPQ during the programming operation. To enable this function, check the "Load EEPROM Image" check box in the options window, and select a file containing the EEPROM image information. Note that the EEPROM image must be contained in an Intel HEX formatted file. You may also provide a name for the image by typing up to 20 characters in the "Image Name" field. The image name defaults to the file name of the selected image file.

F.2.3 OSCCAL Programming

Different members of the AVR families provide a selection of internal oscillators which may be selected as the system clock. Each part provides one or more factory-provided calibration values which, when loaded into the OSCCAL register in the microcontroller, tune the internal oscillator to provide a more accurate frequency setting. The calibration value, or one of the calibration values in the case where multiple values are provided, is automatically loaded into the part's OSCCAL register upon reset. However, the value(s) cannot be read directly by microcontroller firmware. For those applications which require access to the calibration value, MPQ will write the value to a predetermined location in Flash or EEPROM when the part is programmed. TO use this feature, select the desired calibration value from the dropdown box in the Options window, select EEPROM or Flash and provide an address for the value to be programmed. If this feature is not desired, select "None" from the dropdown box in this option frame. This is the default condition.

F.3 - Target Cable Connections

The MPQ-AVR is shipped with two Target Cable assemblies - one for SPI and one for JTAG programming. The connector pinouts correspond to the standard 0.1" x 0.1" spaced 6-pin (SPI) and 10-pin (JTAG) programming connectors specified by Atmel for SPI and JTAG programming. The following tables show the pin assignments for the various connectors. Note that one Target Cable assembly provides four sets of target programming signals.

MPQ-AVR(SPI) Target Cable Connections					
	MPQ Target Connector Pin #	Signal Name	Signal Description	Wire Color	Atmel SPI Pin #
	1	-	Not Used		
Target Port 1	2	Vcc	Target Vcc	Red	2
	3	SCK	Program clock	Blue	3
	4	MOSI	Program Data In	White	4
	5	MISO	Program Data Out	Yellow	1
	6	RESET	Target Device Reset	Violet	5
	7	-	Not Used	-	
	8	GND	Target GND	Black	6
Target Port 2	9	Vcc	Target Vcc	Red	2
	10	SCK	Program clock	Blue	3
	11	MOSI	Program Data In	White	4
	12	MISO	Program Data Out	Yellow	1
	13	RESET	Target Device Reset	Violet	5
	14	-	Not Used	-	
Target Port 3	15	GND	Target GND	Black	6
	16	Vcc	Target Vcc	Red	2
	17	SCK	Program clock	Blue	3
	18	MOSI	Program Data In	White	4
	19	MISO	Program Data Out	Yellow	1
	20	RESET	Target Device Reset	Violet	5
Target Port 4	21	-	Not Used	-	
	22	GND	Target GND	Black	6
	23	Vcc	Target Vcc	Red	2
	24	SCK	Program clock	Blue	3
	25	MOSI	Program Data In	White	4
	26	MISO	Program Data Out	Yellow	1
Target Port 4	27	RESET	Target Device Reset	Violet	5
	28	-	Not Used	-	
	29	GND	Target GND	Black	6
	30	-	Not Used		

NOTE: The GND signal must be common amongst the four target ports when connected to the programmer. All GNDs are tied together internal to MPQ.

MPQ-AVR(JTAG) Target Cable Connections					
	MPQ Target Connector Pin #	Signal Name	Signal Description	Wire Color	Atmel JTAG Pin #
	1	-	Not Used		
Target Port 1	2	Vcc	Target Vcc	Red	4
	3	TCK	Program clock	Blue	1
	4	TDI	Program Data In	White	9
	5	TDO	Program Data Out	Yellow	3
	6	RESET	Target Device Reset	Violet	6
	7	TMS	Program Mode Select	Green	5
	8	GND	Target GND	Black	2
Target Port 2	9	Vcc	Target Vcc	Red	4
	10	TCK	Program clock	Blue	1
	11	TDI	Program Data In	White	9
	12	TDO	Program Data Out	Yellow	3
	13	RESET	Target Device Reset	Violet	6
	14	TMS	Program Mode Select	Green	5
Target Port 3	15	GND	Target GND	Black	2
	16	Vcc	Target Vcc	Red	4
	17	TCK	Program clock	Blue	1
	18	TDI	Program Data In	White	9
	19	TDO	Program Data Out	Yellow	3
	20	RESET	Target Device Reset	Violet	6
Target Port 4	21	TMS	Program Mode Select	Green	5
	22	GND	Target GND	Black	2
	23	Vcc	Target Vcc	Red	4
	24	TCK	Program clock	Blue	1
	25	TDI	Program Data In	White	9
	26	TDO	Program Data Out	Yellow	3
Target Port 4	27	RESET	Target Device Reset	Violet	6
	28	TMS	Program Mode Select	Green	5
	29	GND	Target GND	Black	2
	30	-	Not Used		

NOTE: The GND signal must be common amongst the four target ports when connected to the programmer. All GNDs are tied together internal to MPQ.

Appendix G - Atmel AVR32

This appendix provides details of connection and operation of the MPQ programmer for Atmel AVR32 microcontrollers.

G.1 Device Options

The Device Options in the Load Image and Read Image windows allow the operator to select the device type, operating voltage and programming mode for the image being loaded into MPQ Flash.

MPQ-AVR32 supports only AVR32 Family microcontrollers, so only AVR32 ins available from the Device Family dropdown box in the Load Image or Read Image window.



G.1.1 Device Type

Device Type identifies the particular manufacturer's part number of the device for which the image being loaded is intended. Select the proper device from the dropdown list. MPQ will use this information prior to programming to verify the device ID in the part to be programmed.

G.1.2 Target Voltage

Select the voltage at which the target system V_{io} will be operating during the programming of the device. MPQ will use this information to verify that the target power is at the proper level before beginning the program-

ming operation. The selection of target voltages available in the dropdown list will depend upon the particular device selected in "Device Type", so make the device type selection first.

G.1.3 Mode

There are two Mode selections available for AVR32, "Reset" and "Run". The Mode selection determines whether the target system will be held in reset at the completion of a program cycle ("Reset"), or be reset and then permitted to begin code execution ("Run").

G.2 Programming Options

The AVR32 family offers a variety of programming options which can be selected via MP Manager when the image is loaded into the programmer. From the "Load Image from File" window, click the "Options" button to open the AVR Options window. The options include fuse settings, optional User Memory programming and Security Fuse programming. The desired programming options must be selected prior to clicking the "Load Image" button.

The available programming options are device dependent, so be certain to select the target device from the "Device Type" dropdown list before opening the Options window. Make the desired changes in the Options window, as described below, then click Accept to return to the main Load Image window. You may open the Options window again, to make additional changes or verify values, as many times as necessary before clicking Load Image.

G.2.1 Fuse Values

The AVR32 fuse settings are shown in the Options window. When a device is selected, the fuse values are set to the manufacturer's default values. To modify the fuse values, click on the field that you would like to modify, and an option box will appear, enumerating the available options and allowing you to choose one.